

Patricia Wilcox Peterson

Writing Skills Practice Book for EFL  
Beginning/Intermediate Level



*Developing  
Writing*

# *Developing Writing*

**Writing Skills Practice Book for EFL**  
**Beginning/Intermediate Level**

**Patricia Wilcox Peterson**



UNITED STATES DEPARTMENT OF STATE  
Office of English Language Programs

## Developing Writing

### Writing Skills Practice Book for EFL

Patricia Wilcox Peterson

Originally published in 1982,  
Materials Development and Review Branch  
The English Language Programs Division  
United States Information Agency  
Washington, DC

Second printing published in 1995

This reprint published in 2003.  
Office of English Language Programs  
United States Department of State  
Washington, DC

The author wishes to thank Gloria Kreisher and Dean Curry for their help, as well as book editor Lin Lougheed. She also wishes to thank Luis Roja of Caracas, for his knowledge of Venezuela and his help in providing authentic details of life there.



Office of English Language Programs  
Bureau of Educational and Cultural Affairs  
United States Department of State  
Washington, DC 20547

<http://exchanges.state.gov/education/engteaching/>

# TABLE OF CONTENTS

<b>Introduction</b> .....	<b>ix</b>
<b>Chapter 1: “Square Dancing”</b> .....	<b>1</b>
I. <u>Mechanics</u> : Capital letters at the beginning of sentences and for names. Periods at the end of sentences .....	2
II. <u>Grammar</u> : Subject pronouns .....	2
III. <u>Grammar</u> : Conjugation of <u>be</u> in the present .....	3
IV. <u>Controlled Composition</u> : Dicto-comp .....	4
V. <u>Sentence Construction</u> : Sentence patterns with <u>be</u> .....	4
VI. <u>Sentence Construction</u> : Concentration .....	5
VII. <u>Controlled Composition</u> : Changing from first person to third person pronouns and verbs .....	6
VIII. <u>Vocabulary and Spelling</u> : Puzzle .....	7
<b>Chapter 2: “The Weekend Cook”</b> .....	<b>8</b>
I. <u>Mechanics</u> : Capital letters for nationalities and for the days of the week .....	9
II. <u>Grammar</u> : Third person <u>-s</u> forms in the present tense .....	9
III. <u>Grammar</u> : Subject-verb agreement .....	10
IV. <u>Grammar</u> : Object pronouns .....	10
V. <u>Sentence Construction</u> : Sentence patterns with present tense verbs .....	11
VI. <u>Grammar</u> : Adverbs of frequency with <u>be</u> and other main verbs .....	12
VII. <u>Grammar</u> : Adverbs of time at the beginning of the sentence ..	14
VIII. <u>Controlled Composition</u> : Responding to questions .....	14
IX. <u>Free Composition</u> .....	14
<b>Chapter 3: “That’s Not My Job”</b> .....	<b>15</b>
I. <u>Grammar</u> : Contractions with pronouns and <u>be</u> , <u>be</u> and <u>not</u> .....	16
II. <u>Grammar</u> : Spelling noun plurals .....	16
III. <u>Grammar</u> : Possessive’s with people .....	16
IV. <u>Mechanics</u> : Review of capitalization and punctuation .....	17
V. <u>Grammar</u> : Choosing <u>a</u> or <u>an</u> .....	17
VI. <u>Controlled Composition</u> : Dicto-comp .....	18
VII. <u>Grammar</u> : Subject-verb agreement .....	18
VIII. <u>Sentence Construction</u> : Sentence patterns with present tense verbs .....	18

<b>Chapter 4: “In a Restaurant”</b> .....	<b>20</b>
I. <u>Mechanics</u> : Review of capitalization and punctuation .....	21
II. <u>Grammar</u> : <b>Noun plurals</b> .....	21
III. <u>Grammar</u> : Subject-verb agreement .....	21
IV. <u>Grammar</u> : Articles .....	22
V. <u>Controlled Composition</u> : Dicto-comp .....	22
VI. <u>Sentence Construction</u> : Concentration .....	22
VII. <u>Sentence Construction</u> : Sentence patterns with present tense verbs .....	23
VIII. <u>Vocabulary and Spelling</u> : Puzzle .....	24
 <b>Chapter 5: “Pen Pals: Roberto Writes a Letter”</b> .....	 <b>25</b>
I. <u>Mechanics</u> : A. Noun plurals B. Capital letters for the names of streets, cities, states, and countries. Commas and question marks .....	26
II. <u>Grammar</u> : <b>Possessive adjectives</b> .....	26
III. <u>Controlled Composition</u> : Replacement exercise .....	27
IV. <u>Grammar</u> : <b>Prepositions of place: in, on, at</b> .....	28
V. <u>Grammar</u> : Questions with <b>be</b> .....	28
VI. <u>Grammar</u> : <b>Questions with do</b> .....	29
VII. <u>Sentence Construction</u> : Asking and answering questions.....	30
VIII. <u>Controlled Composition</u> : Incomplete letter.....	30
 <b>Chapter 6: “Pen Pals: Sara Writes Back”</b> .....	 <b>31</b>
I. <u>Mechanics</u> : A. Noun plurals B. The exclamation point .....	32
II. <u>Grammar</u> : <b>Making negative statements with don’t and doesn’t</b> ....	32
III. <u>Mechanics</u> : Review of capitalization and punctuation .....	33
IV. <u>Sentence Construction</u> : <b>Making questions about topics</b> .....	33
V. <u>Sentence Construction</u> : Concentration .....	34
VI. <u>Controlled Composition</u> : Incomplete dialog .....	34
VII. <u>Grammar</u> : Articles .....	35
VIII. <u>Controlled Composition</u> : Dicto-comp .....	35
 <b>Chapter 7: “Enormous Cabbages Show the Effect of Long Alaskan Days”</b> .....	 <b>36</b>
I. <u>Mechanics</u> : Capital letters for the names of continents, oceans, rivers, mountains, valleys, and the months of the year .....	37
II. <u>Grammar</u> : The definite article <u>the</u> before proper names .....	37

III.	<u>Grammar</u> : Sentence combining with <u>and</u> , <u>or</u> , <u>but</u> , and <u>so</u> .....	39
IV.	<u>Sentence Construction</u> : Concentration .....	39
V.	<u>Sentence Construction</u> : Expanding sentences with adjectives .....	40
VI.	<u>Controlled Composition</u> : Incomplete letter .....	41
VII.	<u>Controlled Composition</u> : Incomplete dialog .....	42
VIII.	<u>Vocabulary and Spelling</u> : An Alaskan crossword puzzle.....	43
<b>Chapter 8:</b>	<b>“Food Customs”</b> .....	<b>44</b>
I.	<u>Mechanics</u> : Capitalization and punctuation .....	45
II.	<u>Grammar</u> : Sentence combining with the main verb deleted ....	46
III.	<u>Grammar</u> : Subject-verb agreement .....	47
IV.	<u>Sentence Construction</u> : Noncount nouns .....	47
V.	<u>Grammar</u> : Articles .....	48
VI.	<u>Controlled Composition</u> : Dicto-comp .....	48
VII.	<u>Controlled Composition</u> : Writing about your food habits .....	48
VIII.	<u>Vocabulary and Spelling</u> : Word puzzle .....	49
<b>Chapter 9:</b>	<b>“The Kramers’ Woodpile”</b> .....	<b>50</b>
I.	<u>Mechanics</u> : A. Third person -s forms B. Review of capitalization and punctuation.....	51
II.	<u>Grammar</u> : Review of the rules for articles with common nouns .....	51
III.	<u>Grammar</u> : Using the definite article <u>the</u> for second mention of nouns .....	52
IV.	<u>Controlled Composition</u> : Dicto-comp .....	52
V.	<u>Grammar</u> : Subject-verb agreement .....	53
VI.	<u>Controlled Composition</u> : Responding to a picture .....	53
VII.	<u>Sentence Construction</u> : Words that are both nouns and verbs ..	54
VIII.	<u>Vocabulary and Spelling</u> : Compound nouns .....	54
<b>Chapter 10:</b>	<b>“In the City or in the Suburbs?”</b> .....	<b>55</b>
I.	<u>Grammar</u> : <b>Count and noncount nouns with articles</b> .....	56
II.	<u>Controlled Composition</u> : Dicto-comp .....	56
III.	<u>Sentence Construction</u> : <b>Statements with There is and There are ..</b>	56
IV.	<u>Sentence Construction</u> : Questions with <u>Is there</u> and <u>Are there</u> ..	58
V.	<u>Grammar</u> : Word order with adverb phrases .....	59
VI.	<u>Grammar</u> : Sentence combining review .....	59
VII.	<u>Controlled Composition</u> : Incomplete letter.....	60
VIII.	<u>Vocabulary and Spelling</u> : Compound nouns .....	61

<b>Chapter 11: “Riddles”</b> .....	<b>62</b>
I. <u>Grammar</u> : Review of verbs in yes-no questions .....	63
II. <u>Grammar</u> : Information questions .....	63
III. <u>Sentence Construction</u> : Concentration .....	64
IV. <u>Grammar</u> : Possessives with things .....	65
V. <u>Sentence Construction</u> : Writing riddles .....	66
VI. <u>Grammar</u> : Choosing prepositions .....	67
VII. <u>Controlled Composition</u> : Choosing relevant information .....	67
VIII. <u>Vocabulary and Spelling</u> : Puns .....	68
<b>Chapter 12: “Crowding”</b> .....	<b>70</b>
I. <u>Mechanics</u> : Using commas in a series .....	71
II. <u>Grammar</u> : Spelling -ing verb forms .....	71
III. <u>Grammar</u> : Subject-verb agreement .....	72
IV. <u>Controlled Composition</u> : Dicto-comp .....	72
V. <u>Grammar</u> : The definite article <u>the</u> before prepositional phrases .....	73
VI. <u>Sentence Construction</u> : Making questions about topics .....	73
VII. <u>Controlled Composition</u> : Incomplete dialog .....	74
VIII. <u>Controlled Composition</u> : Choosing relevant information .....	75
<b>Chapter 13: “Corner Stores and Supermarkets”</b> .....	<b>77</b>
I. <u>Mechanics</u> : A. Spelling of -ing forms B. Capital letters for the names of companies and stores .....	78
II. <u>Grammar</u> : Comparison of adjectives .....	78
III. <u>Sentence Construction</u> : Making comparisons .....	80
IV. <u>Controlled Composition</u> : Choosing relevant information .....	81
V. <u>Controlled Composition</u> : Dicto-comp .....	81
VI. <u>Grammar</u> : The definite article <u>the</u> with specific groups .....	82
VII. <u>Controlled Composition</u> : Variety in sentence types .....	82
VIII. <u>Vocabulary and Spelling</u> : Crossword puzzle .....	83
<b>Chapter 14: “Family Roles”</b> .....	<b>84</b>
I. <u>Mechanics</u> : A. Noun plurals B. The colon before a list of examples.....	85
II. <u>Grammar</u> : The past tense of <u>to be</u> .....	85
III. <u>Grammar</u> : The past tense with regular verbs .....	86
IV. <u>Controlled Composition</u> : Dicto-comp .....	87
V. <u>Sentence Construction</u> : Comparisons with <u>more</u> , <u>less</u> , and <u>fewer</u> .....	87

VI.	<u>Grammar</u> : Sentence combining: compound sentence parts.....	88
VII.	<u>Controlled Composition</u> : Variety in sentence types .....	89
VIII.	<u>Controlled Composition</u> : Choosing relevant information .....	90
<b>Chapter 15:</b>	<b>“Tall Tales” .....</b>	<b>91</b>
I.	<u>Mechanics</u> : A. Review of comparisons .....	93
	B. Quotation marks.....	93
II.	<u>Grammar</u> : Past tense irregular verbs.....	94
III.	<u>Controlled Composition</u> : Dicto-comp .....	94
IV.	<u>Sentence Construction</u> : Questions and negatives with <u>did</u> .....	94
V.	<u>Grammar</u> : Using <u>very</u> , <u>too</u> , <u>enough</u> , <u>so...that</u> , and <u>such...that</u> .....	95
VI.	<u>Controlled Composition</u> : Organizing ideas .....	96
VII.	<u>Controlled Composition</u> : Responding to a picture .....	97
VIII.	<u>Controlled Composition</u> : Responding to a picture .....	98
<b>Chapter 16:</b>	<b>“Making a Banana Split” .....</b>	<b>99</b>
I.	<u>Mechanics</u> : A. Regular and irregular past tense verbs B. Using a comma after a subordinate clause .....	101
II.	<u>Grammar</u> : The past progressive tense .....	101
III.	<u>Controlled Composition</u> : Past narration .....	102
IV.	<u>Grammar</u> : Sentence combining with adverb clauses .....	102
V.	<u>Grammar</u> : Review of articles, <u>some</u> as a quantifier.....	103
VI.	<u>Controlled Composition</u> : Dicto-comp .....	103
VII.	<u>Controlled Composition</u> : Organizing ideas .....	104
VIII.	<u>Controlled Composition</u> : Past narration .....	104
IX.	<u>Free Composition</u> .....	104
<b>Chapter 17:</b>	<b>“A Debate: Dogs in the City” .....</b>	<b>105</b>
I.	<u>Mechanics</u> : A. Review of comparisons B. The semi-colon in sentence combining .....	106
II.	<u>Grammar</u> : Sentence combining with subordinate conjunctions and conjunctive adverbs .....	107
III.	<u>Sentence Construction</u> : Concentration .....	108
IV.	<u>Grammar</u> : Modal auxiliaries .....	109
V.	<u>Controlled Composition</u> : Dicto-comp .....	110
VI.	<u>Controlled Composition</u> : Variety in sentence types .....	110
VII.	<u>Controlled Composition</u> : Incomplete dialog .....	111
VIII.	<u>Free Composition</u> .....	112



<b>Chapter 18: “Planning a Trip”</b> .....	<b>114</b>
I. <u>Mechanics</u> : Contractions with <u>have</u> and <u>will</u> .....	115
II. <u>Sentence Construction</u> : The present perfect tense .....	115
III. <u>Controlled Composition</u> : Incomplete dialog .....	117
IV. <u>Controlled Composition</u> : Dicto-comp .....	117
V. <u>Grammar</u> : Indefinite pronouns: <u>some</u> , <u>any</u> , and <u>one</u> .....	118
VI. <u>Grammar</u> : Sentence combining practice .....	118
VII. <u>Sentence Construction</u> : Writing complete sentences .....	119
VIII. <u>Vocabulary and Spelling</u> : Past participles as adjectives .....	120
<b>Chapter 19: “Phobias”</b> .....	<b>122</b>
I. <u>Mechanics</u> : Nonrestrictive relative clauses .....	123
II. <u>Grammar</u> : Restrictive relative clauses .....	123
III. <u>Grammar</u> : Subject-verb agreement .....	124
IV. <u>Controlled Composition</u> : Dicto-comp .....	125
V. <u>Sentence Construction</u> : Writing definitions .....	125
VI. <u>Grammar</u> : Substituting <u>that</u> for <u>which</u> or <u>who</u> .....	125
VII. <u>Controlled Composition</u> : Organizing ideas .....	126
VIII. <u>Vocabulary and Spelling</u> : Present participles as adjectives .....	127
<b>Chapter 20: “A Day at the Beach”</b> .....	<b>128</b>
I. <u>Mechanics</u> : Quotations and paragraphs .....	129
II. <u>Grammar</u> : Final review of articles .....	129
III. <u>Controlled Composition</u> : Dicto-comp .....	130
IV. <u>Grammar</u> : Reduced relative clauses .....	130
V. <u>Sentence Construction</u> : Indefinite pronouns: <u>one</u> , <u>ones</u> , and <u>kind</u> .....	131
VI. <u>Grammar</u> : Choosing prepositions .....	132
VII. <u>Controlled Composition</u> : Variety in sentence types .....	133
VIII. <u>Vocabulary and Spelling</u> : Crossword puzzle of irregular verbs .....	133
<b>Appendix A: Common Irregular Verbs</b> .....	<b>135</b>
<b>Appendix B: Review of Grammar</b> .....	<b>138</b>
<b>Appendix C: Answers to Puzzles</b> .....	<b>141</b>

## INTRODUCTION TO THE TEACHER

The goal of this book is to take the student from the mechanics of basic sentence writing to the ability to construct a simple paragraph. The vocabulary and the structures have been planned chapter by chapter, from simple to more complex, and the lessons build on each other. For this reason, the students will probably benefit the most if they do the exercises in each chapter in the order they are presented. The same is true of the order of the chapters: information presented early in the book will be helpful for the writing tasks in the later chapters.

The amount of time needed to work through a chapter depends on the level of the students, the length of the class period, and the teacher's decision about homework. Some groups may finish a chapter in two hours, with two hours of outside work. Other groups may do all the exercises in class in four or five hours. Two sample lesson plans are suggested at the end of this section, one with homework assignments and one without homework.

Each chapter includes some of the following exercises:

1. **Text** The text is a reading selection that contains the model structures upon which the chapter is based. There is a variety of styles and registers of English. Some of the texts are descriptions; some are narratives; some are newspaper articles; some are dialogs; and some are letters.

The teacher may read the text out loud, or he may ask the students to read it silently. The texts in dialog form (chapters 3, 10 and 20) are suitable for dramatic reading in pairs. After the first reading, the teacher may want to clarify new vocabulary words and ask a few comprehension questions.

2. **Mechanics** This section helps to reinforce the new vocabulary, ideas, and structures in the text. To present the section, the teacher should explain the rule of punctuation or capitalization to the class, and write the example or the first problem on the board. Then the students can do the remaining problems.

One effective method for checking the students' work is to divide the chalkboard into sections and ask each student to write one answer in a section. Several students can do this at once, to save class time. Then the class as a whole can read and correct the boardwork. This self-

correction builds awareness of the mechanical rules of English and should encourage careful writing.

**3. Grammar** Many types of structures are included under this heading. Essentially everything that is rule-based is included here: question transformations, negation, tenses, and sentence combining. One particularly important goal of the book is to give practice in the use of articles. Rules for article use are introduced very gradually and drilled repeatedly. An index to grammatical information is given in the appendices in the back of the book.

The teacher will want to discuss the rule briefly before the students do an exercise, and the class should do one or two problems together so the teacher is sure that they understand. Many grammar exercises can be done orally first, and this strengthens the students' listening and speaking skills. Oral work is appropriate for sentence combining, word order exercises, question transformations, negations, and tense work. It may be especially useful to read the article exercises aloud, to help the students develop a sense of correctness with English articles. When the students write out the problems, they may work individually or in pairs. Work should always be collected, corrected, and returned for the students to see.

**4. Sentence Construction** Exercises under this heading introduce elements of free choice in writing. The students are given some sentence parts, but they must put the sentence together in their own way. Often there is more than one correct response to each problem.

These exercises may be done in class or as homework. Since these exercises involve the beginning of some original thought, students often like to see each other's work. Sentences can be written on the board, corrected, and discussed. The incomplete dialogs in chapters 3, 6, 7, 12, and 17 should provide enjoyment if the students read them aloud in pairs. One type of sentence construction exercise, the game of Concentration, must be done in class with a partner.

**5. Controlled Composition** The purpose of these exercises is to give practice in writing student-generated short paragraphs, letters, dialogs, and other units longer than a single sentence. Some of the exercises are suitable for homework, and some can be best done in class. Another way to handle these compositions is to hold a writing lab within the classroom. In this procedure, each student works independently; the teacher walks around the room, commenting on the papers and

helping students one by one. Especially good compositions can be read aloud at the end of the lab period.

A few composition exercises are of the highly controlled variety, in which the students' task is basically to copy a given text and to make certain required changes of tense, pronoun usage, or similar changes. These occur primarily in the first half of the book, when the students' grammatical repertoire is still fairly limited.

Dicto-comps are used in almost every chapter to form a bridge between grammar work and free writing. They resemble dictations in that the content has been predetermined. However, as the directions indicate, the students are not asked to write a word-for-word copy of the original. Rather, they are to listen three times before writing, and then to compose a paragraph from memory, as close to the wording of the original as possible.

Partly completed compositions with large blanks are a kind of controlled composition that calls for more student input. These assignments provide the students with choices that are varied enough to allow an opportunity for expression, but controlled enough to make incorrect combinations rather unlikely. By completing each sentence appropriately, students can practice writing paragraphs, letters, and memos in their own words, conforming to a standard form.

Some composition assignments are almost entirely free, stimulated by a list of questions or a picture. When this kind of assignment is given, there has been a previous text in the chapter which can serve as a model.

In the second half of the book there are exercises that treat the process of composition as a problem of arranging and ordering ideas. In these assignments, sentences are given to the students, but they are out of order. The students' task is to rewrite the composition in a logical order.

**6. Vocabulary and Spelling** Often the final section of a chapter is a game activity. There are puzzles and word games to expand student vocabulary and to focus attention on accurate spelling. In this section, as well as in the grammar section, attention is given to the spelling and usage of inflectional and derivational affixes. These sections are intended to bring some fun to the drudgery of spelling work. They should be done in class in pairs or even in teams. At the end of a unit, the teacher may want to reward the class by arranging a competitive game, in which two teams try to be the first to complete a puzzle.

Below are two possible time schedules for a typical chapter in the book.

<b>Two-Hour Plan with Homework</b>	<b>Four-Hour Plan with no Homework</b>
<p>Day one  <b>Text</b> Read the text aloud or silently, clarify vocabulary, and ask comprehension questions.  <b>Mechanics</b> Explain the rule, have students write the sentences on the board, and correct their work.  <b>Grammar</b> Review the rule and do some problems orally. Students write out the exercise individually or in pairs. Collect the papers.  <b>Homework</b> Sentence Construction Exercise</p>	<p>Day One  <b>Text</b> Read the text aloud or silently, clarify vocabulary, and ask comprehension questions.  <b>Mechanics</b> Explain the rule, have students write the sentences on the board, and correct their work.  <b>Grammar</b> Review the rule and do some problems orally. Students write out the exercise individually or in pairs. Collect the papers.</p>
<p>Day Two  <b>Correct</b> the Sentence Construction exercise in class and compare answers.  <b>Dicto-Comp</b>  <b>Puzzle</b> Students work in pairs or in teams.  <b>Homework</b> Controlled Composition</p>	<p>Day Two  <b>Sentence Construction</b> exercise            Have students act out dialogs, compare different student answers, or do Concentration game in class.  <b>Dicto-Comp</b></p>
	<p>Day Three  <b>Controlled Composition</b>            Use the writing lab technique. The students may do one or more compositions, as time permits.</p>
	<p>Day Four  <b>Discuss</b> the student compositions and compare them. Have students read each other's work to develop a critical eye.  <b>Puzzle</b> Team game</p>



## SQUARE DANCING

Hello. I am Ernie Anderson. I am a truck driver. I am from the United States.

Here is a picture of my wife and me. We are with our friends. We are square dancers. Dancing is not our work. It is our hobby.



The square dance is an old American dance for four couples. A couple is one man and one woman. Three other couples are in our square. Their names are Bob and Marsha, Doug and Cathy, and Henry and Eileen.

My wife's name is Hazel. Her dress is short and full. It is a square-dance dress. We are in the front on the left. The music is very fast right now.

I. **Mechanics** Capital letters at the beginning of sentences and for names. Periods at the end of sentences.

Each new sentence begins with a capital letter and ends with a period (.)

This is a good sentence, this is not correct

Names begin with capital letters, too:

Ernie Anderson Bob and Marsha Kovacik

Copy the sentences, and make all the corrections that are necessary.

1. i am ernie anderson
2. i am from the united states
3. we are square dancers
4. dancing is our hobby
5. it is an american dance
6. bob and marsha are our friends
7. henry and eileen are another couple
8. a couple is a man and a woman
9. hazel is my wife
10. we are in the front of the picture

II. **Grammar** Subject pronouns

Study the pronouns below. Then rewrite each sentence and substitute the appropriate pronoun for each name.

I (the speaker)	we (the speaker and others)
you (the second person)	you (plural)
he (masculine) she (feminine) it (things and animals)	they (plural for men, women, things, or animals)



Ernie Bob Doug Henry Eileen Cathy Marsha Hazel

1. Bob is a dancer.  
He is a dancer.
2. Ernie is a truck driver.
3. Doug is from America.
4. Doug, Ernie, and Bob are friends.
5. Hazel and Eileen are friends.
6. Cathy and Marsha are in the picture.
7. Hazel is Ernie's wife.
8. Hazel is a square dancer.
9. Dancing is not work.
10. The music is very fast.
11. The dresses are short and full.
12. The picture is from last year.

### III. Grammar The verb to be

Study the forms for the verb to be. Then copy the paragraph below, writing in the correct form.

I am	we are
you are	you are
he	they are
she is	
it	

Square dancing \_\_\_\_\_ fun. The music \_\_\_\_\_ fast, and the people \_\_\_\_\_ friendly. Ernie \_\_\_\_\_ at the dance every week. Hazel \_\_\_\_\_ with him. She \_\_\_\_\_ a good dancer. Six friends \_\_\_\_\_ with them in a square. They \_\_\_\_\_ happy to be there.



#### IV. **Controlled Composition** Dicto-comp

Your teacher will read the paragraph above three times. Listen carefully, but do not take notes. After the third reading, write the paragraph as well as you can from memory.

#### V. **Sentence Construction** Sentence patterns with be

The verb to be connects the subject of a sentence to another word that tells us something about the subject. This second word or phrase after the verb may be another noun, an adjective, or an adverb. In this way, we can see three different basic sentence patterns with the verb to be.

1. Sentence patterns with noun phrases. The word or phrase after the verb may tell us what or who the subject is:

The square dance is an old American dance.  
Noun phrase + be + Noun phrase

On the left is a list of subjects. On the right is a list of noun phrases, telling what or who. Choose a subject and a verb and match them with a noun phrase on the right to make a sentence. Write as many sentences as you can. Example: Ernie is a truck driver.

<u>Noun phrase</u>	+	<u>be</u>	+	<u>Noun phrase</u>
Ernie		is		a truck driver
Hazel		are		his wife
They				square dancers
Bob and Marsha				Ernie's friends
Dancing				fun
Doug and Cathy				not work
				a hobby
				another couple

2. Sentence patterns with adjectives The word or phrase after the verb may tell us how the subject is, or what it is like:

The music is very fast.  
Noun phrase + be + Adjective

On the left is a list of subjects. On the right is a list of adjectives telling how. Choose a subject and a verb and match them with an adjective on the right to make a sentence. Write as many sentences as you can.

<u>Noun phrase</u>	+	<u>be</u>	+	<u>Adjective</u>
I		am		happy
You		are		welcome
The dresses		is		short and full
The music				fast
The dance				American

3. Sentence patterns with adverb phrases. The word or phrase after the verb may tell us where the subject is, or where it is from:

Ernie is from the United States.  
Noun phrase + be + Adverb phrase

On the left is a list of subjects. On the right is a list of adverb phrases. Choose a subject and a verb and match them with an adverb phrase on the right to make a sentence. Write as many sentences as you can.

<u>Noun phrase</u>	+	<u>be</u>	+	<u>Adverb phrase</u>
Four couples		is		from the United States
We		are		in a square
They		am		on the right
Ernie and Hazel				in the front
Bob				in the picture
I				with my wife

## VI. **Sentence Construction** Concentration

This is a game you can play with another person. Cut squares of paper to fit over each box below. Cover each box with a square of paper. Have a pencil and paper ready to write sentences.

The first player turns over two squares. He reads the words in the boxes. If they make a good sentence, he writes the sentence on his paper. He leaves the boxes uncovered. If the words do not go together in a sentence, he covers them again. (Remember what is under each square of paper!) The second player takes his turn. Continue playing

until all the squares are uncovered.

The player with the most sentences on his paper is the winner.

Dancing is	The dresses are	one man and one woman.	A couple is
The music is	very fast.	a good dancer.	welcome to dance.
our friends.	I am	our hobby.	You are
short and full.	a truck driver.	They are	My wife is

**VII. Controlled Composition** Changing from first person to third

Ernie Anderson wrote the paragraph below. He used the first-person pronouns I and we. Rewrite the paragraph and tell about Ernie. Make all the necessary changes in pronouns: I → he      my → his  
we → they      our → their

I am Ernie Anderson. I am a truck driver. I am from the United States. This is my wife. My wife's name is Hazel. Her dress is short and full. It is a square-dance dress. We are square dancers. We are with our friends. Three other couples are in our square. Dancing is not our work. It is our hobby.

### VIII. Vocabulary and Spelling Puzzle

In the puzzle below there are 20 words from this chapter. They may be located horizontally, vertically, or diagonally. See how many of the words in the list you can find.

d	a	n	c	i	n	g	i	s
r	b	d	r	e	s	s	b	h
i	h	c	a	s	h	q	t	o
v	w	o	c	h	a	u	i	r
e	o	u	b	e	p	a	m	t
r	r	p	e	b	p	r	r	w
f	k	l	g	w	y	e	l	e
u	x	e	f	r	i	e	n	d
l	m	u	s	i	c	f	w	h
l	p	i	c	t	u	r	e	e

- |         |         |
|---------|---------|
| he      | hobby   |
| she     | work    |
| it      | couple  |
| we      | happy   |
| is      | square  |
| are     | friend  |
| am      | wife    |
| driver  | picture |
| dancing | full    |
| dress   | short   |
| music   |         |

## THE WEEKEND COOK



My dad works in a bank. He works there from Monday to Friday. He helps people. He counts money, and he uses the computer. His job is important. He is an important man at the bank.

Dad also works at home. On weekends he cooks dinner. Usually he fixes Italian food. On Saturdays he makes spaghetti. On Sundays he makes pizza. Sometimes he fries chicken or fixes Chinese food. My mother watches and helps. She cuts the vegetables. She tosses the salad. I wash the dishes.

Some people say it is strange for a man to cook. My dad enjoys his hobby. Cooking relaxes him. His father was a weekend cook, too.

I. **Mechanics** Capital letters for nationalities and for the days of the week

Names of nationalities begin with capital letters:

Italian Chinese Venezuelan American

The days of the week begin with capital letters, too.

Sunday Monday Tuesday Wednesday Thursday  
Friday Saturday

Copy the sentences, and make all the corrections that are necessary.

1. my father is a weekend cook
2. he works at a bank on monday, tuesday, wednesday, thursday, and friday
3. he cooks on saturday and sunday
4. usually he cooks Italian spaghetti
5. pizza is italian food
6. dad makes spaghetti on saturdays
7. my dad likes to cook chinese food
8. my mother and i help my dad
9. it is good for my dad to cook
10. his hobby relaxes him

II. **Grammar** Third person -s forms. Spelling of present tense verbs

Notice that verbs in the present tense take an ending with he, she, and it. The spelling of this ending may be -s or -es.

I help	we help
you help	you help
he help <u>s</u>	
she help <u>s</u>	
it help <u>s</u>	they help

1. Almost all verbs add -s in the third person singular. Write the forms below with the correct spelling.

He works. (work, know, count, make, use)

She cuts. (cut, help, cook, dance)

2. A few verbs add -es in the third person singular. They are verbs that end in s, z, sh, ch, or x. Write the forms below with the correct spelling.

He fixes, (fix, finish, relax, rush)

She watches, (watch, toss, wash, teach)

3. If a verb ends in a consonant and -y, change the y to i before adding -es. If the verb ends in a vowel and -y, simply add s; Write the forms below with the correct spelling.

He tries, (try, fry, study, hurry, carry, marry)

She says, (say, enjoy, play, stay, buy, pay)

4. The verb have is irregular. The third person singular form is has.  
He has a cookbook.

### III. Grammar Subject-verb agreement

Rewrite the sentences below, adding the correct form of the verb. Remember that he, she, and it take -s forms.

1. Most women cook the dinners at home. (cook)
2. My mother cooks most of the time. (cook)
3. She \_\_\_\_\_ dinner on Mondays, Tuesdays, Wednesdays, and Thursdays. (make)
4. My father \_\_\_\_\_ Italian food on the weekends. (fix)
5. My brother and I \_\_\_\_\_ the dishes. (wash)
6. We \_\_\_\_\_ the salad, too. (help with)
7. I \_\_\_\_\_ to cook already. (know how)
8. Cooking \_\_\_\_\_ my father. (relax)
9. Important people \_\_\_\_\_ and \_\_\_\_\_ all day. (rush, hurry)
10. Often they \_\_\_\_\_ a hobby after work. (enjoy)

### IV. Grammar Object pronouns

These are the forms of pronouns when they are the object of a verb or a preposition.

I → me	we → us
you → you	you → you
he → him	they → them
she → her	
it → it	

Rewrite each sentence and substitute an object pronoun for each noun. Follow the example.

1. My father helps people. My father helps them.
2. My father uses the computer.
3. My mother washes the vegetables.
4. I cut the vegetables.
5. My dad enjoys cooking.
6. He enjoys helping my mother.
7. Cooking relaxes my father.
8. My mother teaches my father to cook.
9. My dad teaches (his son.)
10. My mother helps my dad and me.

#### V. **Sentence Construction** Sentence patterns with verbs other than be

In chapter one you learned three sentence patterns with the verb to be:

Noun phrase	+	be	+	Noun phrase
Noun phrase	+	be	+	Adjective
Noun phrase	+	be	+	Adverb phrase

Other verbs can also be put in groups, according to the kinds of words that come after them. A verb that takes an object after it is a transitive verb (Verb<sub>T</sub>). Transitive verbs occur in this pattern:

My father cooks dinner.  
 Noun phrase    +    Verb<sub>T</sub>    +    Noun phrase

On the left is a list of subjects. On the right is a list of noun phrases that can be used as objects. Choose a subject and a verb and match them with an object to make a sentence. You may need to add -s or -es to the verb. Make as many sentences as you can.

Noun phrase	+	Verb	+	Noun phrase
My father		cook		dinner
Cooking		relax		him
He		enjoy		his hobby
My mother		help		his wife
She		wash		the vegetables
I		fix		the salad
We		eat		the dishes
				pizza and spaghetti



Verbs that cannot take an object are intransitive (Verb<sub>1</sub>). Intransitive verbs occur in two patterns:

My mother works.  
Noun phrase + Verb<sub>1</sub>

My father works in a bank.  
Noun phrase + Verb<sub>1</sub> + Adverb phrase

On the left is a list of subjects. On the right is a list of adverb phrases that can be used with intransitive verbs. Choose a subject and a verb and match them with an adverb phrase to make a sentence. You may need to add -s or -es to the verb. Make as many sentences as you can.

<u>Noun phrase</u>	+	<u>Verb</u>	+	<u>Noun phrase</u>
My father		work		very hard
My mother		cook		in a bank
He				on the weekend
She		relax		in the kitchen
We				after work
I				together

## VI. Grammar Adverbs of frequency with the be verb.

Adverbs of frequency tell how often something happens. These words come after a form of the verb to be;

Father is never late.  
Mother is usually busy.  
Junior is always hungry.

Below is a schedule that tells where each person in the family is during the week. Look at the schedule, and then write all the sentences with adverbs of frequency in the correct position. Use this scale as a guide: 7 days a week = always; 5 or 6 = usually; 4 = often; 2 or 3 = sometimes; 1 = rarely; and 0 = never.

	Sunday	Monday	Tuesday	Wednesday	Thursday	Friday	Saturday
Dad	at home	at the bank	at the bank	at the bank	at the bank	at the bank	at home
Mother	at home	at work	at home	at work	at home	at work	at home
Junior	at home	at school	at school	at school	at school	at school	at home

1. Dad is \_\_\_\_\_ at the bank.
2. Junior is \_\_\_\_\_ at school.
3. Mother is \_\_\_\_\_ at home.
4. She is \_\_\_\_\_ at work.
5. They are \_\_\_\_\_ at home on the weekends.
6. They are \_\_\_\_\_ at home on Mondays.

Adverbs of frequency with other main verbs

The adverbs of frequency come before other main verbs besides to be.

Junior always helps at home.  
 Father sometimes cooks dinner.  
 Mother often works in the kitchen.

Look at the schedule below. It is a work plan for a family. Write all the sentences below with adverbs of frequency, telling how often each person works.

	Sun	Mon	Tues	Wed	Thurs	Fri	Sat
Cook dinner	Dad	Mother	Mother	Mother	Mother	Mother	Dad
Cut vegetables	Mother	Junior	Junior	Junior	Junior	Dad	Mother
Toss the salad	Mother	Mother	Mother	Mother	Mother	Dad	Mother
Wash the dishes	Junior	Junior	Junior	Junior	Junior	Junior	Junior

1. Junior \_\_\_\_\_ washes the dishes.
2. Mother and Dad \_\_\_\_\_ wash the dishes.
3. Mother \_\_\_\_\_ tosses the salad.
4. Junior \_\_\_\_\_ tosses the salad.
5. Mother \_\_\_\_\_ cooks dinner.
6. Dad \_\_\_\_\_ cooks dinner.
7. Dad \_\_\_\_\_ cuts vegetables.
8. Junior \_\_\_\_\_ cuts vegetables.
9. Mother \_\_\_\_\_ cuts vegetables.
10. These people \_\_\_\_\_ work together.

**VII. Grammar** Adverbs of time at the beginning of the sentence

Sometimes adverbs of time can come at the beginning of a sentence. Rewrite these sentences and place the adverb or phrase at the beginning.

1. Nobody is at home on Mondays. On Mondays nobody is at home.
2. Dad works at the bank from Monday to Friday.
3. Mom teaches at a school on Mondays, Wednesdays, and Fridays.
4. Junior is usually at school.
5. Everybody is at home on weekends.
6. Dad often cooks spaghetti or pizza.
7. Mother sometimes goes out to work.
8. She usually rushes home to fix dinner.
9. Mother works very hard on Fridays.
10. Dad usually helps her with the salad on Fridays.

**VIII. Controlled Composition** Responding to questions

Make a chart to show where the people in your family are each day.

Name	Sunday	Monday	Tuesday	Wednesday	Thursday	Friday	Saturday

Find a partner in the class and discuss your chart with him. Ask him questions about his time chart, too. Then write a paragraph to answer these questions: Where is everyone on week days? Where is everyone on weekends? Where is your mother, usually? Where is your father, usually? Where are you?

**IX. Free Composition**

Write a paragraph and tell who does the work in your family.

## THAT'S NOT MY JOB

A customer comes into the Westside Pharmacy. He's very sick.

Clerk: May I help you?

Customer: Yes, please. I have a pain in my side, an ache in my stomach, and a headache. I need a pill, an aspirin, or a painkiller... something fast.

Clerk: I'm sorry, but that's not my job. That's Mr. Brown's job. He's the head pharmacist.

Customer: May I see Mr. Brown, please.

Clerk: I'm sorry. Mr. Brown is busy. He's on the phone.

Customer: Then his helper.

Clerk: She's busy, too. Please wait.

Customer: Oh, no.

Clerk: Oh, here's Mr. Brown.

Mr. Brown: Yes? May I help you?

Customer: I have a pain in my side, an ache in my stomach, and a headache. Please give me a pill.

Mr. Brown: That isn't my job. I'm not a doctor. I'm a pharmacist. Dr. Saunders has an office next to us. His address is 215 Grand Avenue. Come back with a prescription. We can help you then.



## I. Grammar Contractions: subject pronouns and be, be and not

In informal English, we can combine a pronoun and a verb in the following ways:

I + am = I'm	he + is = he's	we + are = we're
you + are = you're	she + is = she's	they + are = they're
that + is = that's	it + is = it's	

Rewrite the sentences below and use contractions.

- |                               |                         |
|-------------------------------|-------------------------|
| 1. He is the head pharmacist. | 6. It is his office.    |
| 2. She is his helper.         | 7. We are busy.         |
| 3. That is my job.            | 8. They are here.       |
| 4. I am a pharmacist.         | 9. You are sick.        |
| 5. He is a doctor.            | 10. That is an aspirin. |

We can also combine the verb with the word not:

is + not = isn't	are + not = aren't
------------------	--------------------

Rewrite the sentences below and use contractions with not.

- |                        |                                |
|------------------------|--------------------------------|
| 1. That is not my job. | 4. We are not busy today.      |
| 2. He is not a doctor. | 5. They are not in the office. |
| 3. She is not here.    | 6. It is not time for lunch.   |

## II. Grammar Spelling noun plurals

Noun plurals follow the same spelling rules as the -s forms of present tense verbs. Add -s for most nouns; add -es if the noun ends in s, z, sh, ch, or x. Nouns that end in a consonant and y change the y to i and add -es. Write the plural form for each noun below.

1. Add -s to: pain, ache, pill, aspirin, job, problem, office, doctor, pharmacist, helper, prescription
2. Add -es to: lunch, dish, box, dress, tax
3. Change the y to i and add -es: family, pharmacy, country, city, hobby

## III. Grammar Possessive 's with people

To show possession, use an apostrophe (') after the person's name and add -s. Write the forms below.

1. Mr. Brown has a helper.      Mr. Brown's helper

2. Mr. Brown has a job.
3. The doctor has an office.
4. The customer has a prescription.
5. The helper has a job.
6. My dad has a hobby.
7. Ernie has a wife.
8. Hazel has a dress.

If the person's name ends with -s, then simply add the apostrophe:

Dr. Saunders has an office.                    Dr. Saunders' office

For plural nouns, the apostrophe comes after the -s ending. Write the forms below.

1. The Browns have a pharmacy.    the Browns' pharmacy
2. The customers have problems.
3. Bankers have short work hours.
4. Square dancers have short skirts.
5. Truck drivers have schedules.

#### IV. **Mechanics** Review of capitalization and punctuation

Copy the paragraph below, and make all the corrections that are necessary. Use apostrophes for contractions and possessives.

ruth bennet works in mr browns pharmacy she is mr browns helper sometimes a customer wants a prescription that isnt ruths job shes a pharmacists helper she isnt a doctor sometimes an aspirin will help the customers headache its ruths job to give out aspirin

#### V. **Grammar** Articles: choosing a or an

To choose between a or an, listen to the beginning sound (not the spelling) of a word. If the word begins with a vowel sound, use an; If it begins with a consonant sound, use a; Write the lists below with an article before each word.

##### Vowel sounds

\_\_\_ aspirin

\_\_\_ address

\_\_\_ idea

\_\_\_ ache

\_\_\_ office

\_\_\_ Italian

\_\_\_ American

### Consonant sounds

___pill	___problem
___pain	___doctor
___pharmacy	___dance
___headache	___hobby
___job	___cook
___helper	___bank

### VI. **Controlled Composition** Dicto-comp

Your teacher will read the dialog below three times. Listen carefully, but do not take notes. After the third reading, write the dialog as well as you can from memory. Listen carefully for the articles a and an.

Customer: I have a pain in my side, an ache in my stomach, and a headache! Give me a pill!

Mr. Brown: That isn't my job. I'm not a doctor. I'm a pharmacist. Dr. Saunders has an office next to us. Get a prescription from him and come back. We can help you then.

### VII. **Grammar** Subject-verb agreement

Write the sentences below and change all the singular nouns to plural nouns. You will not need an article before the plural noun. You will also need to change the verb forms from singular to plural.

1. A banker works with money.      Bankers work with money.
2. A pharmacist works with prescriptions.
3. A doctor eats a quick lunch.
4. A banker eats a long, slow lunch.
5. A pharmacist's helper works in a pharmacy.
6. A good boy helps his family.
7. A mother usually washes dishes.
8. A square dancer usually wears a short dress.
9. I always have a headache on a busy day.
10. A doctor writes a prescription for a painkiller.

VIII. **Sentence Construction** Sentence patterns with present tense verbs

Review the sentence patterns we have learned so far.

Noun phrase + be + Noun phrase  
 Noun phrase + be + Adjective  
 Noun phrase + be + Adverb phrase  
 Noun phrase + Verb<sub>T</sub> Noun phrase  
 Noun phrase + Verb<sub>I</sub>  
 Noun phrase + Verb<sub>I</sub> + Adverb phrase

Make as many good sentences as you can by choosing verbs from the lists below. Remember that each sentence in the present tense can take only one verb.

<u>Noun phrase</u> The customer He An aspirin Mr. Brown Mr. Brown's helper Mr. Saunders	+  <u>Verb</u> be have (Verb <sub>T</sub> ) need (Verb <sub>T</sub> ) work (Verb <sub>I</sub> )	+  <u>Noun phrase</u> an aspirin a headache a painkiller a pharmacist an office  <u>Adjective</u> very sick busy  <u>Adverb phrase</u> out to lunch in the pharmacy here next to us on the phone
---	---	--



## IN A RESTAURANT



Peter Day is a cook. He cooks in a restaurant. Peter cooks on a grill. He grills meat for hamburgers. Next to Peter is Pauline. Pauline is also a cook. She puts sandwiches together. Peter and Pauline are very busy. They work quickly. They make hundreds of sandwiches every day.

Many customers order sandwiches every day. The waitresses write orders on small pieces of paper. Pauline reads the orders and calls to Peter, "Two hamburgers and a steak, medium." Then a waitress picks up the food, and brings it to her customers. The waitresses bring three or four orders at a time. The customers eat their sandwiches and pay for the food.

Many customers order sandwiches every day. The waitresses write orders on small pieces of paper. Pauline reads the orders and calls to Peter, "Two hamburgers and a steak, medium."



## I. **Mechanics** Review of capitalization and punctuation

Copy the sentences, and make all the corrections that are necessary.

1. many people work in restaurants
2. peter and pauline work together
3. pauline isnt a waitress
4. shes a cook
5. she puts sandwiches together
6. pauline reads the orders and calls them out to peter
7. its very busy in the restaurant
8. many customers order food every day
9. the cooks work quickly
10. the customers eat and pay for the food

## II. **Grammar** Noun plurals

Make each noun plural by adding -s or -es.

- |               |             |
|---------------|-------------|
| 1. cook       | 6. waitress |
| 2. restaurant | 7. customer |
| 3. grill      | 8. order    |
| 4. hamburger  | 9. piece    |
| 5. sandwich   | 10. steak   |

## III. **Grammar** Subject-verb agreement

Each sentence below has a singular subject and an article (a or an) before it. Change the subject and the verb to a plural form. You will not need an article before plural nouns.

1. A cook is a busy worker. Cooks are busy workers.
2. A restaurant is a busy place.
3. A customer is a hungry person, (person → people)
4. A grill is very hot.
5. A hamburger is a small piece of meat between bread.
6. A hamburger is a hot sandwich.
7. An order is on a small piece of paper.

Continue to make each sentence plural. You will not need an -s ending on the verb. You will not need an article before plural nouns.

8. A cook works in a restaurant.  
Cooks work in restaurants.
9. A cook works at a grill.
10. A customer orders a sandwich.
11. A customer sits at a table.
12. A waitress brings many orders at a time.
13. A cook reads the orders.
14. A cook makes many sandwiches every day.
15. A customer pays money for food.

#### IV. Grammar Articles

Decide whether an article is needed in each blank. Write either a, an, or X (if no article is needed). Do not look back at the text until you are finished. Then use the text to check your work.

\_\_\_\_\_ Peter is \_\_\_\_\_ cook. \_\_\_\_\_ cooks work in \_\_\_\_\_ restaurants.  
 \_\_\_\_\_ Peter cooks at \_\_\_\_\_ grill. He grills meat for \_\_\_\_\_ hamburgers.  
 Next to \_\_\_\_\_ Peter is \_\_\_\_\_ Pauline. \_\_\_\_\_ Pauline is also \_\_\_\_\_  
 cook. She puts \_\_\_\_\_ sandwiches together. Then \_\_\_\_\_ waitress picks  
 up the food and brings it to her customers.

Do you need an article before somebody's name?

Do you need an article before a singular noun?

Do you need an article before a plural noun, usually?

#### V. Controlled Composition Dicto-comp

Your teacher will read the paragraph above three times. Listen carefully, but do not take notes. After the third reading, write the paragraph as well as you can from memory. Check your paper for articles and for subject-verb agreement.

#### VI. Sentence Construction Concentration

This is a game you can play with another person. Cut squares of paper to fit over each box below. Cover each box with a square of paper. Have a pencil and paper ready to write sentences.

The first player turns over two squares. He reads the words in the boxes. If they make a good sentence, he writes the sentence on his paper. He leaves the boxes uncovered. If the words do not go together in a

sentence, he covers them again. (Remember what is under each square of paper!) The second player takes his turn. Continue playing until all the squares are uncovered.

The player with the most sentences on his paper is the winner.

grills meat for sandwiches	give work to many people	orders food	put sandwiches together
a customer	a restaurant	a waitress	waitresses
is a busy place	customers	pick up food	a cook
cooks	brings orders to the cook	sit at tables	restaurants

## VII. **Sentence Construction** Sentence patterns with present tense verbs

Make as many good sentences as you can by choosing words from the lists below. For each sentence, choose only one verb.

<u>Subject</u>	<u>Verb</u>	<u>Object or Complement</u>
Peter and Pauline	are	very busy
Pauline	is	cooks
The waitress	calls	the orders
They	picks up	in a restaurant
The customers	puts together	hamburgers
The restaurant	cooks	next to Paul
Cooks	order	meat for sandwiches
A hamburger	work	quickly
	pay for	on a grill
		a hot sandwich

### VIII. Vocabulary and Spelling Puzzle

In the puzzle below are 15 words from this chapter. They may be located horizontally, vertically, or diagonally. See how many of the words in the list you can find in the puzzle.

r	m	c	w	f	o	o	d	a	b
s	e	u	a	s	r	h	c	d	y
a	a	s	i	t	d	a	e	s	w
n	t	t	t	e	e	m	u	p	o
d	f	o	r	a	r	b	g	a	r
w	h	m	e	k	u	u	m	u	k
i	f	e	s	n	g	r	i	l	l
c	o	r	s	p	r	g	a	i	s
h	o	c	o	o	k	e	t	n	u
w	d	P	e	t	e	r	y	e	t

- |            |       |
|------------|-------|
| customer   | busy  |
| restaurant | steak |
| waitress   | food  |
| hamburger  | order |
| grill      | work  |
| Pauline    |       |
| meat       |       |
| Peter      |       |
| cook       |       |
| sandwich   |       |

## PEN PALS: ROBERTO WRITES A LETTER

Calle Motatan, Qta. Los tres  
Colinas de Bello Monte  
Caracas, Venezuela 1041  
September 23, 1982

Dear Sara,

I am very happy to introduce myself to you. My name is Roberto Perez. I live in Caracas, Venezuela. My English teacher is Sra. Rodriguez. She had your name on a list of pen pals. Would you like to be pen pals with me? We can write letters to each other every month.

I am fourteen years old. My hobbies are swimming, soccer, and playing records. My father works in a bank, and my mother is a housewife. I have one sister. Her name is Teresa. I also have a brother. His name is Alfredo. We are all students in high school. Our grandparents live with us. We also have a dog and two cats.

My city is always very pleasant. The weather is warm all year long. Our winters are wet and rainy, but they are not cold. I see that you live in Fairbanks, Alaska. Is your city cold? Do you have any brothers and sisters? Are you in high school, too? Do you have any hobbies? Please write and tell me about yourself. Maybe someday we can visit each other.

Sincerely,

*Roberto Perez*

P.S. Here is a picture of my family. I am very tall. My eyes are brown, and my hair is black. Please send a picture of yourself.

## I. Mechanics

### A. Noun plurals

A few noun plurals are irregular. The plural form for wife is wives; housewife becomes housewives. The plural for person is people. Follow the rules in chapter 3, section II and make these nouns plural: letter, name, teacher, list, pen pal, month, year, hobby, housewife, student, person, city, winter, eye, picture

B. Capital letters for the names of streets, cities, states, and countries. Commas and question marks.

We use a capital letter for street names, the names of cities, states, and countries. In an address, the city and state are separated by a comma.

1239 Lincoln Boulevard  
Fairbanks, Alaska 99701  
U.S.A.

A question ends with a question mark:

Is the weather warm in Venezuela?

Copy the sentences, and make all the corrections that are necessary.

1. roberto lives in Caracas Venezuela
2. sara lives in the united states
3. her home is in fairbanks alaska
4. she lives at 1239 lincoln boulevard
5. is the weather pleasant in Venezuela
6. are the winters cold in fairbanks
7. my sisters name is teresa
8. my brothers name is alfredo
9. do you have any brothers and sisters
10. do you have any hobbies

## II. Grammar Possessive adjectives

Below are the words that are used before nouns to show possession.

I → my	he → his	we → our
you → your	she → her	they → their
	it → its (no apostrophe!)	

Look at the picture of Roberto's family. Copy the sentences and use possessive adjectives.



1. I have a large family. \_\_\_\_\_ My family is large.
2. We have a home in Caracas.
3. You have a home in Alaska.
4. Alfredo has a black dog.
5. The dog has the name Charlie.
6. Teresa has white cats.
7. They have the names Tilin and Nieve.
8. I have a grandmother in the house, too.
9. Grandmother has two hobbies, reading and sewing.
10. We have a large family.

### III. **Controlled Composition** Replacement exercise

#### A. Writing about Roberto's Family

Read the model paragraph below and then look at the information about Alfredo and Teresa. Rewrite the model paragraph and use the information about Alfredo to write a description of him. Write another paragraph and use the information about Teresa to describe her.

Roberto is a boy from Venezuela. He lives in Caracas. He is fourteen years old. He studies English in school. His hair is black. His eyes are brown. His favorite sport is soccer. His hobbies are swimming, soccer,



and playing records. Roberta has one brother. His name is Alfredo. Roberto has one sister, too. Her name is Teresa. Roberto has a pet parakeet. Its name is Pele.

**Alfredo**

13 years old  
 hobbies: riding a bicycle,  
                   watching T.V.  
 hair color: brown  
 eyes: brown  
 favorite sport: running  
 foreign language: English  
 pet: one dog named Charlie

**Teresa**

16 years old  
 hobbies: dancing, playing the piano, singing  
 hair color: brown  
 eyes: blue  
 favorite singer: Jose Luis Rodriguez  
 favorite dance: the Hustle  
 foreign languages: English and French  
 pets: two cats named Tilin and Nieve

B. Writing about Yourself

Use the model paragraph and replace the information about Roberto with information about yourself.

IV. **Grammar** Prepositions of place: in, on, at

When you give your address, you use these prepositions.

- in: a country, a state, a city, a district, a continent
- on: a street (a boulevard, an avenue, a lane, a drive, a highway)
- at: a specific address or place such as at home, at work, at the bank

Use the information below and write as many sentences as you can. Choose in, on, or at for each sentence.

<u>Subject</u>	<u>Verb</u>	<u>Complement</u>
Roberto	lives	 <ul style="list-style-type: none"> <li>North America</li> <li>South America</li> <li>Venezuela</li> <li>the United States</li> <li>Caracas</li> <li>Fairbanks</li> <li>Alaska</li> <li>Lincoln Boulevard</li> <li>1239 Lincoln Boulevard</li> </ul>
Sara	works	
Mrs. Taylor		
Mr. Perez		
He	in	
She	on	
They	at	

## V. Grammar Questions with be

To make a simple yes-no question with the verb to be, change the order of the subject and the verb. Rewrite the sentences below as questions. Make sure each question ends with a question mark.

1. His name is Roberta.      Is his name Roberto?
2. His teacher is Mrs. Rodriguez.
3. Sara is Roberta's pen pal.
4. She is from Alaska.
5. He is from Venezuela.
6. Roberto is very tall.
7. His family is large.
8. The weather in Venezuela is warm all year long.
9. The winters in Venezuela are wet and rainy.
10. The winters in Alaska are very cold.

## VI. Grammar Questions with do

To make a simple yes-no question with other main verbs in the present tense, you need to add a helping verb, do or does. The helping verb goes before the subject.

Do	I you we they	have a pen pal?	Does	he she it	live in Caracas?
----	------------------------	-----------------	------	-----------------	------------------

(Notice that the main verb in a question has no -s or -es ending.)

Rewrite the sentences below as questions. Make sure each question ends with a question mark.

1. Sara lives in the United States.      Does Sara live in the United States?
2. Roberto lives in Caracas.      States?
3. His father works in a bank.
4. His mother works at home.
5. His grandparents live in the house.
6. His brother and sister go to high school.
7. They have pen pals, too.
8. I have your address.
9. We know your telephone number.
10. You play soccer as a hobby.

**VII. Sentence Construction** Asking and answering questions

When you write a letter to a pen pal, you can ask many questions that begin, "Do you have any...?" Make a question for each topic below, and then answer it.

- 1. brothers and sisters    Do you have any brothers and sisters?
- 2. hobbies
- 3. pen pals
- 4. grandparents
- 5. records
- 6. pictures of yourself
- 7. dogs
- 8. cats

**VIII. Controlled Composition** Incomplete letter

Use the form below. You may add more sentences if you wish. Be sure to give your correct address at the top. Use correct punctuation and capitalization.

	Number and Street City, State, Postal Code Country Month and Day, Year
Dear _____,	
I am very happy to _____. My name is _____. I live in _____. Would you like _____? We can _____.	
I am _____ years old. I am _____. My eyes are _____, and my hair is _____. My hobbies are _____. My father _____, and my mother _____. I have _____ in my family, too. Their names are _____.	
My city is _____. The weather is _____. The winters are _____. Do you have any _____? Do you have any _____? Do you have any _____? Are you _____? Are you _____? Please write and tell me about yourself.	
Sincerely, _____	

## PEN PALS: SARA WRITES BACK



1239 Lincoln Boulevard  
Fairbanks, Alaska 99701  
U.S.A.  
October 7, 1982

Dear Roberto,

I was very happy to receive your letter. Thank you! Yes, I would really like to be pen pals with you. I am very interested in South America. My uncle works for a company in Venezuela. Maybe next summer I can go to visit him there. (Wow! Super!) Until then, we can send pictures to each other.

Your family is very different from mine. I don't have a large family. I live with my mother here in Fairbanks. She works for a T.V. station. My father died ten years ago. I don't have any brothers and sisters. I have one grandmother in Chicago, Illinois. My other grandmother lives in Miami, Florida. We don't see each other very often.

My hobbies are dancing, swimming, and foreign languages. I study Spanish and French in high school. Maybe next time I can write in Spanish. I have two cats. We don't have a dog because our apartment is too small.

The weather in Alaska really isn't so bad. I like it a lot here. It isn't as cold as you think. Here is a picture of me and a newspaper story about Alaska for you. It's called "Enormous cabbages Show the Effect of Long Alaskan Days." I hope to hear from you soon.

Sincerely,

*Sara Taylor*

## I. Mechanics

### A. Noun plurals

Follow the rules in chapter 3, section II and make these nouns plural: summer, company, family, sister, brother, parent, T.V. station, grandmother, dog, cat, apartment, story, cabbage, effect.

### B. The exclamation point (!)

The exclamation point shows strong emotion or excitement. Sara likes to show her feelings in letters, and so she uses the exclamation point.

Copy the three sentences, words, or phrases that end with an exclamation point.

1. Thank you!
2. \_\_\_\_\_
3. \_\_\_\_\_

## II. Grammar Making negative statements with don't and doesn't

To make a sentence negative in the present tense, you need the helping verb do or does. These contractions are common in informal writing and speech:

do + not = don't

does + not = doesn't

Rewrite each sentence below and make it negative. Change the subject from Roberto to Sara. You may use contractions.

1. Roberto has a large family. Sara doesn't have a large family.
2. Roberto has a father.
3. Roberta's mother stays home.
4. Roberto has a brother.
5. Roberto has a sister.
6. Roberto's grandparents live with the family.
7. Roberto sees his grandparents often.
8. Roberto lives in a big house.
9. Alfredo owns a big dog.
10. Roberto owns a parakeet.

### III. Mechanics Copyreading: capitalization and punctuation

Copy the letter, and make all the changes that are necessary. Remember the rules for commas, apostrophes, question marks, and exclamation points.

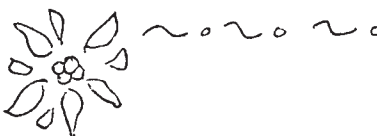
o	~				
					
S			1239 lincoln boulevard		S
o			fairbanks alaska 99701		o
			u s a		S
S			October 15 1982		o
o		dear roberto			S
		i am very happy today do you know the reason my uncle says i			o
S		can visit Venezuela next summer wow super i can also see my			S
o		grandmother in Chicago illinois and my other grandmother in			o
		miami florida i can speak Spanish in miami i am coming to			S
S		Caracas on June 1 is it a good time to visit you i hope so			o
o					S
S			sincerely		o
			sara		o

### IV. Sentence Construction Making question about topics

There is usually more than one way to ask a question. For each topic below you may ask a question at least two ways. Use the vocabulary that is given and write as many questions as you can. You may have to change the word order and add helping verbs.

- family size  
your family / be / large    Is your family large?  
you / have / any brothers and sisters    Do you have any brothers and sisters?
- home place  
you / live / in Venezuela  
your home / be / in Venezuela
- hobbies  
you / have / any hobbies    you / play / soccer  
you / like / any sports    you / be / a soccer player

4. weather  
the weather / be / cold / in your country  
the winters / be / long / in your country
5. work  
your father / work / in a bank      your mother / work / at home  
your father / be / a banker          your mother / be / a housewife
6. study  
you / be / a student  
you / study / English

**V. Sentence Construction**    Concentration

This is a game you can play with another person. Cut squares of paper to fit over each box below. Cover each box with a square of paper. Have a pencil and paper ready to write sentences.

The first player turns over two squares. He reads the words in the boxes. If they make a good question, he writes the question on his paper. He leaves the boxes uncovered. If the words do not go together in a question, he covers them again. (Remember what is under each square of paper!) The second player takes his turn. Continue playing until all the squares are uncovered.

The player with the most questions on his paper is the winner.

Do you have	Roberto?	Do you live	Is your family
very often?	any brothers?	Are the winters	blond?
in Caracas?	Do you see your grandmother	Is your name	Are the summers
Is your hair	very cold?	very hot?	very large?

**VI. Controlled Composition**    Incomplete dialog

Below are the answers to some questions. Write a good question before each answer. When you finish you will have a dialog that you can act out with a partner.

A: Do you have a large family?  
 B: Yes, we have a very large family.  
 A: \_\_\_\_\_  
 B: Yes, I have three brothers and five sisters.  
 A: \_\_\_\_\_  
 B: Yes, we have three dogs and three cats.  
 A: \_\_\_\_\_  
 B: Yes, all my grandparents live with the family.  
 A: \_\_\_\_\_  
 B: Yes, everyone in the family has a hobby.  
 A: \_\_\_\_\_  
 B: Yes, we have a piano in each room.  
 A: \_\_\_\_\_  
 B: Yes, we have ten rooms in our house.  
 A: \_\_\_\_\_  
 B: Yes, our house is very large.  
 A: \_\_\_\_\_  
 B: Yes, our neighbors are often angry.

## VII. Grammar Articles

Remember the rules about articles:

1. Use no article before somebody's name.
2. Use an article before a singular noun.
3. Use no article (usually) before a plural noun.

Decide whether an article is needed in each blank. Write either a, an, or X (if no article is needed).

\_\_\_\_\_ Roberto has \_\_\_\_\_ large family and many pets. He has \_\_\_\_\_ sister and \_\_\_\_\_ brother. They have \_\_\_\_\_ parakeet, \_\_\_\_\_ dog, and two cats. They have \_\_\_\_\_ large house.

\_\_\_\_\_ Sara likes dogs, but she has \_\_\_\_\_ cat. She lives in \_\_\_\_\_ small apartment. Usually \_\_\_\_\_ dogs are not happy in \_\_\_\_\_ apartments. Maybe \_\_\_\_\_ Sara can get \_\_\_\_\_ house some day. Then she can have \_\_\_\_\_ dog.

## VIII. Controlled Composition Dicto-comp

Your teacher will read one or both of the paragraphs above three times. Listen carefully, but do not take notes. After the third reading, write the paragraph as well as you can from memory.



## ENORMOUS CABBAGES SHOW THE EFFECT OF LONG ALASKAN DAYS

(Fairbanks) Last Saturday at the Tanana Valley Fair, Oscar Lindstrom won first prize for a sixty-pound cabbage. Lindstrom grows the cabbages in Alaska, just outside the city of Fairbanks.

Lindstrom says, "I don't have any secrets for growing big cabbages. They always grow big. The land along the Tanana River is good, and the weather is warm here."

Many people think that Alaska is always cold, but it isn't. Ocean winds bring warm air to the outer parts, so they are mild. The inside part of the state has cold winters (-23 to -34°C), but summers can be hot. The temperature is usually between 7 and 24°C near Fairbanks.

Winter comes early, so the growing season is short. The ground freezes in October, and winter lasts until May. Lindstrom has only 89 growing days, but that is enough. In summer the days are long, and nights are short. Each night is only a few hours long, so Lindstrom's cabbages receive a lot



of sunlight. They grow without stopping.

People at the fair talk about the cabbages every year: "Big cabbages!" "Enormous cabbages!" "Enormous, delicious, leafy green cabbages."

Alaskans may grow more vegetables in the future, but now good land is limited. Mountains cover the land, or trees grow on it. Most of the state's food comes from the outside, so prices are high. Alaskans work hard, and they like their wild state. Alaska is still new, so many young Americans are moving there. The state's motto is: "North to the Future."



I. **Mechanics** Capital letters for the names of continents, oceans, rivers, mountains, valleys, and the months of the year

The names of continents, oceans, rivers, mountains, and valleys begin with capital letters.

South America                      the Yukon River  
the Indian Ocean                  the Yukon Valley

The months of the year also begin with capital letters:

January   February   March   April   May   June   July  
August   September   October   November   December

Copy the sentences below, and make all the corrections that are necessary.

1. oscar lindstrom lives outside fairbanks alaska
2. he grows cabbages in the tanana valley
3. land by the tanana river is very good
4. the ground is frozen from october to may
5. vegetables can grow in june, july, and august
6. the arctic ocean is to the north of alaska
7. the bering sea is to the west of alaska
8. on the south are the gulf of alaska and the pacific ocean
9. the most famous river in alaska is the yukon
10. mount mckinley is the highest mountain in alaska and it is also the highest mountain in north america

II. **Grammar** Using the definite article the before proper names

The definite article is sometimes used as part of a name. You should use the before the names of rivers, oceans, seas, and valleys. Don't use the before continents, states, cities, or single mountains. Usually, countries don't have the before them. There are some exceptions:

1. the Netherlands, the Sudan
2. Countries with the word Union or United
3. Full titles of countries with prepositional phrases

Use the for:

Rivers

the Nile

the Amazon

the Mississippi

Oceans and Seas

the Atlantic Ocean

the Sea of Japan

the Mediterranean

Sea

Valleys

the Red River

Valley

the Nile Valley

Don't use the for:

Continents

Asia

Africa

Europe

States

New York

California

Florida

Cities

Miami

Tokyo

Caracas

Single mountains

Mount Washington

Mount Everest

Mount Fuji

Countries:

China

Nigeria

Venezuela

But:

the Netherlands

the Sudan

the Union of Soviet

Socialist Republics

the United States of

America

the Federal Republic

of Germany

the People's Republic

of China

Copy the sentences below. Use an article (a, an, or the) where you need one. If you don't need an article, mark the place with an X.

1. Oscar Lindstrom is \_\_\_\_\_ farmer.
2. He grows \_\_\_\_\_ cabbages in \_\_\_\_\_ Tanana River Valley.
3. \_\_\_\_\_ cabbage is \_\_\_\_\_ vegetable.
4. \_\_\_\_\_ Fairbanks has \_\_\_\_\_ long, cold winters and \_\_\_\_\_ short, warm summers.
5. In summer, \_\_\_\_\_ days are long and \_\_\_\_\_ nights are short.
6. \_\_\_\_\_ Lindstrom won \_\_\_\_\_ prize for \_\_\_\_\_ cabbage at \_\_\_\_\_ fair last summer.
7. \_\_\_\_\_ mountains and \_\_\_\_\_ trees cover \_\_\_\_\_ Alaska, so good land is limited.
8. \_\_\_\_\_ Alaska is famous for \_\_\_\_\_ Mount McKinley, \_\_\_\_\_ Yukon River, and for \_\_\_\_\_ big cabbages.
9. It is located in \_\_\_\_\_ North America, west of \_\_\_\_\_ Canada.
10. \_\_\_\_\_ Alaska gets \_\_\_\_\_ warm winds from \_\_\_\_\_ Pacific Ocean.

### III. Grammar Sentence combining

Two short sentences can be combined into one long sentence by using a coordinate conjunction: and, but, or, so. Use a comma before the conjunction to separate the two parts of the sentence.

<u>and</u>	combines similar ideas	<u>but</u>	combines opposite ideas
<u>or</u>	shows a choice	<u>so</u>	shows a result

Combine each pair of sentences below into one longer sentence by using a coordinate conjunction.

1. Winter comes early. The growing season is short. (so)  
Winter comes early, so the growing season is short.
2. The ground freezes in October. Winter lasts until May. (and)
3. Lindstrom has only 89 days. That is long enough. (but)
4. In summer, days are long. Nights are short. (and)
5. Each night is only a few hours long. Lindstrom's cabbages receive a lot of sunlight. (so)
6. The cabbages grow without stopping. They are enormous. (so)
7. Many people think that Alaska is always cold. It isn't. (but)
8. Ocean winds bring warm air. The outer parts are mild. (so)
9. The winters are cold. The summers are hot. (but)
10. Alaskans may grow more vegetables in the future. Now good land is limited. (but)
11. Mountains cover the land. Trees grow there. (or)
12. Most food comes from the outside. Prices are high. (so)
13. Alaskans work hard. They like their wild state. (and)
14. Alaska is still new. Many Americans are moving to Alaska. (so)

### IV. Sentence Construction Concentration

This is a game you can play with another person. Cut squares of paper to fit over each box below. Cover each box with a square of paper. Have a pencil and paper ready to write sentences.

The first player turns over two squares. He reads the words in the boxes. If they make a good sentence, he writes the sentence on his paper. He leaves the boxes uncovered. If the sentences do not go together to make a long sentence, he covers them again. (Remember what is under each square of paper!) The second player takes his turn. Continue playing until all the squares are uncovered.

The player with the most sentences on his paper is the winner.

Winters are cold in Fairbanks,	so it won first prize.	and the land by the river is good.	or you can live inside the state.
You can live by the ocean,	Summers by the Tanana are hot,	so the state is growing fast.	Summer days are long,
Many people are moving to Alaska,	but winters are mild by the ocean.	Lindstrom's cabbage was sixty pounds,	Alaskan farmers grow some food now,
so food is very expensive there.	Most food comes from outside Alaska,	but winter days are short.	and they will grow more food in the future.

## V. Sentence Construction Expanding sentences with adjectives

Adjectives in English can come after the verb to be, and they can come before the noun. Study the examples below.

Lindstrom's cabbages are enormous.

Lindstrom grows enormous cabbages.

If you use more than one adjective to describe a noun, the adjectives follow a certain order. First come the adjectives of number, then size or shape, then condition, color, and origin. Choose from the lists below and expand the following sentences with adjectives. See how many different sentences you can make. You may use several adjectives in each sentence.

<u>Number</u>	<u>Size or Shape</u>	<u>Condition</u>	<u>Color</u>	<u>Origin</u>	
one (a, an)	enormous	happy	slow	green	Alaskan
two	long	leafy	delicious	dark	Italian
three	short	hot	important	light	Venezuelan
four	sixty-pound	pleasant	wet	black	American
one hundred	small	cold	friendly	white	Pacific
many	large	mild	rainy	red	
most	full	busy	snowy		
all			quick		

1. Lindstrom grows...cabbages.  
Lindstrom grows many sixty-pound Alaskan cabbages.  
Lindstrom grows enormous leafy green cabbages.
2. Fairbanks has...winters.
3. Fairbanks has...summers.
4. The outer parts of Alaska receive...winds.
5. Roberta has...family.
6. They live in...house.
7. He has...cats.
8. Sara lives in...apartment.
9. Paul and Pauline work in...restaurant.
10. They put together...sandwiches.
11. My father has...job.
12. He also cooks...dinners at home.
13. Ernie and Hazel have...friends.
14. The women wear...dresses for dancing.

**VI. Controlled Composition** Incomplete letter

Copy the letter below and complete the sentences so that they make sense.

October 30, 1982
<p>Dear Sara,</p> <p>Thank you for the newspaper story about Alaska. It is very interesting. Now I know many new things about your state. Here is what I know:</p> <p>Many people think that Alaska is always cold, but _____. The winters in Fairbanks are ____, but _____. Ocean winds bring _____, so _____. Farmers in Alaska grow _____. The summer days are very long, so _____. The growing season is ____, so _____. Most food comes from outside the state, and _____. Many people are moving ____, so _____. They work hard, and _____.</p> <p>I am so happy that you are coming to Caracas in June. Please visit us. You can stay with my family. My mother says that you are welcome.</p> <p style="text-align: right;">"Yours," <i>Roberto</i></p>

## VII. **Controlled Composition** Incomplete dialog

Below are the answers to some questions. Write a good question before each answer. When you finish you will have a dialog that you can act out with a partner.

### “A Newspaper Reporter Talks with Oscar Lindstrom”

Reporter: \_\_\_\_\_?

Lindstrom: Yes, I'm Oscar Lindstrom.

Reporter: \_\_\_\_\_?

Lindstrom: Yes, I'm a farmer in the Tanana Valley.

Reporter: \_\_\_\_\_?

Lindstrom: Yes, my farm is near Fairbanks.

Reporter: \_\_\_\_\_?

Lindstrom: Yes, this is my sixty-pound cabbage.

Reporter: \_\_\_\_\_?

Lindstrom: No, I don't always grow cabbages so big, but I always try.

Reporter: \_\_\_\_\_?

Lindstrom: No, I don't have any secrets for growing big cabbages. They always grow big. The weather is good here.

Reporter: \_\_\_\_\_?

Lindstrom: Yes, we have enough warm weather here. We have 89 growing days every summer.

Reporter: \_\_\_\_\_?

Lindstrom: No, I don't grow any other vegetables. Cabbages are strong, but other vegetables aren't.

Reporter: \_\_\_\_\_?

Lindstrom: No, I don't grow tomatoes. Tomatoes need a longer growing season.

Reporter: \_\_\_\_\_?

Lindstrom: Yes, some people do. They grow hot-house tomatoes inside special buildings, but most of our tomatoes come from outside Alaska.

Reporter: \_\_\_\_\_?

Lindstrom: Yes, they're very expensive, so I save my money. I eat green, leafy vegetables, like cabbage.

VIII Vocabulary and Spelling An Alaskan crossword puzzle

DOWN

1. The \_\_\_\_\_ is good by the Tanana River.
3. Canada is \_\_\_\_\_ of Alaska.
4. Many towns in Alaska are \_\_\_\_\_.
5. The highest mountain in the U.S. is Mount \_\_\_\_\_.
6. McKinley was a U.S. president; now his name is on a \_\_\_\_\_.
7. A city in inland Alaska.
9. Part of Alaska is inside the \_\_\_\_\_ circle.
11. Summers in Fairbanks can be \_\_\_\_\_.
13. The Pacific is an \_\_\_\_\_.

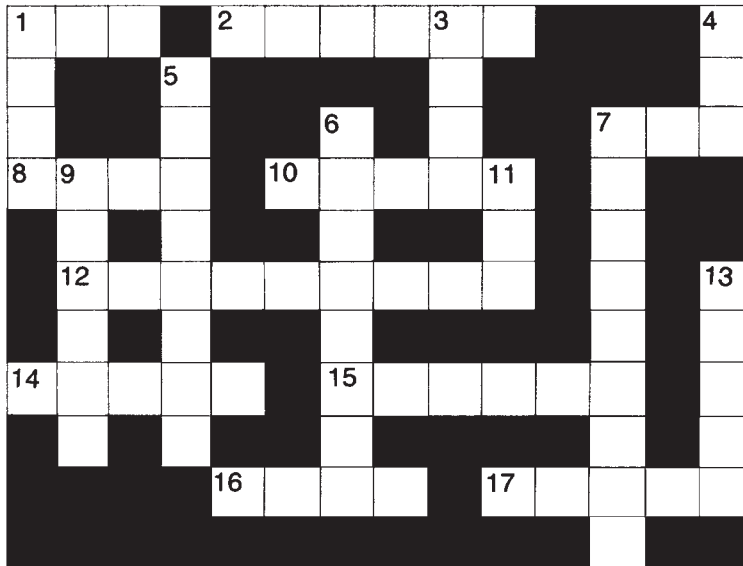

ACROSS

1. The Pacific Ocean winds bring a \_\_\_\_\_ of rain.
2. Fairbanks is in the Tanana River \_\_\_\_\_.
7. Alaska has too \_\_\_\_\_ days in the summer to grow tomatoes.
8. In winter, the nights are long and \_\_\_\_\_.
10. Anchorage, Sitka, and Juneau are \_\_\_\_\_ of Fairbanks.
12. North America is a \_\_\_\_\_.
14. The Yukon is a \_\_\_\_\_.
15. The state in the U.S. that is the farthest north.
16. A summer month.
17. A river in Alaska.



## FOOD CUSTOMS

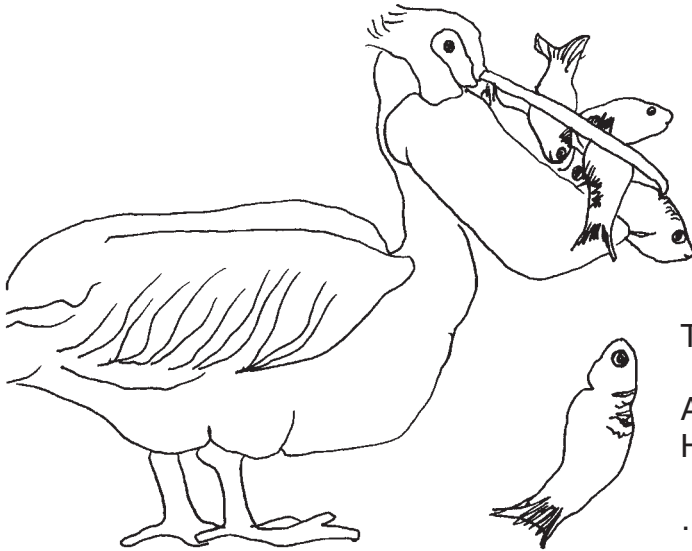

The Pelican

A wonderful bird is the pelican,  
His bill will hold more than  
his belican ["belly can"]  
... from Dixon Merritt (1879-1954)

A pelican is a bird with a very large bill, or beak. He uses his beak to pick up a lot of fish. He can't eat all the fish at one time. He must hold them in his beak until his stomach is ready. Of course, this doesn't bother the pelican at all. It is his habit to eat this way. However, it seems strange to the poet Dixon Merritt.

People have food habits and customs, too. These are activities that we do all the time. But people are different from pelicans. We tell our children not to take too much food. "Your eyes are bigger than your stomach," we say. It is too bad to take more food than we can eat.

Other food customs tell us not to eat certain kinds of food. The health food movement is new, but it is popular. These people don't eat much sugar, and they don't drink strong coffee, tea, or alcohol. Vegetarians don't eat meat. There are many reasons for this. They don't want to kill animals. They don't want to become fat, and meat has a lot of fat. Some vegetarians just don't like the taste of meat.

We have another saying about food: "One man's meat is another man's poison."

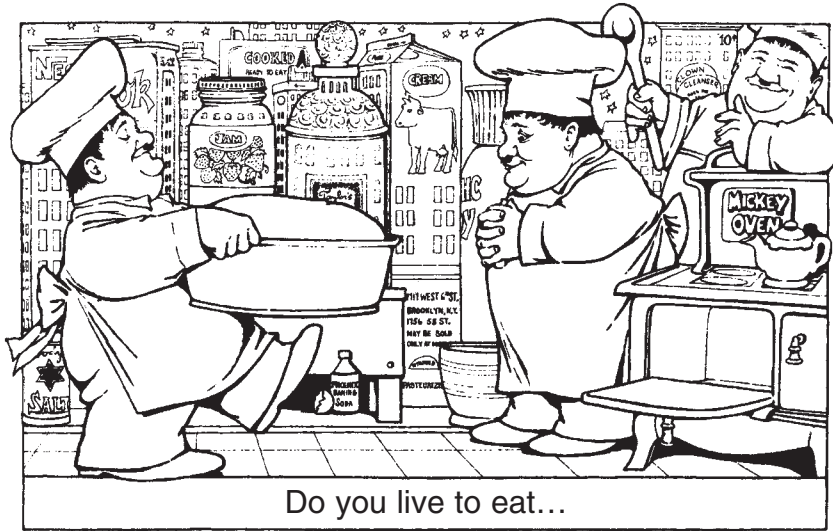

Do you live to eat...



...or do you eat to live?

## I. **Mechanics** Capitalization and punctuation

Copy the sentences and make all the changes that are necessary. Use apostrophes for contractions.

1. a pelican holds a lot of fish in his beak
2. does this seem strange to you
3. it s not strange to a pelican

4. are your eyes bigger than your stomach
5. health food doesn't have much sugar
6. vegetarians don't eat meat
7. they don't like the taste of meat
8. one man's meat is another man's poison

## II. Grammar    Sentence combining with the main verb deleted

In the last chapter you learned to combine sentences with and and but. And is used to join sentences with similar meanings. But shows different meanings.

In some pairs of sentences, everything is the same except the subjects. Then you may leave out the main verb and the words that come after it, and use the auxiliary verb alone. Study these examples:

1. Two positive sentences (similar in meaning)  
 Pelicans have food habits. People have food habits.  
 Pelicans have food habits, and people do, too.  
 (Do is the auxiliary verb. Leave out have food habits.)
2. Two negative sentences (similar in meaning)  
 Coffee isn't an alcoholic drink. Tea isn't an alcoholic drink.  
 Coffee isn't an alcoholic drink, and tea isn't either.  
 (Be is its own auxiliary verb. Leave out an alcoholic drink.)
3. A positive and a negative sentence (different in meaning)  
 Some people eat meat. I don't eat meat.  
 Some people eat meat, but I don't.  
 (Do is the verb substitute. Leave out eat meat.)

Combine the sentences below with and or but. Leave out the main verb and the words that come after it.

1. Pelicans don't have large stomachs. Children don't have large stomachs.
2. Pelicans take a lot of food. Children don't take a lot of food.
3. Most people eat meat. Vegetarians don't eat meat.
4. Alcohol isn't good for children. Coffee isn't good for children.
5. Cabbages are vegetables. Potatoes are vegetables.
6. Pork is a kind of meat. Beef is a kind of meat.
7. Coffee isn't an alcoholic drink. Wine is an alcoholic drink.
8. Some people drink tea. I don't drink tea.

9. Meat is good for you. Vegetables are good for you.
10. Sugar isn't a health food. Coffee isn't a health food.

### III. Grammar Subject-verb agreement

Each sentence below has a singular subject and an article (a or an) before it. Change the subject to a plural form. Change the verb. You will not need an article before the plural noun.

1. A pelican is a bird with a big beak.  
Pelicans are birds with big beaks.
2. A pelican has strange food habits.
3. A pelican picks up fish in its beak.
4. A pelican takes more food than it eats at one time.
5. A person is different from a pelican.
6. A person has food habits, too.
7. A cabbage is a vegetable.
8. A vegetarian does not eat meat.
9. A habit is an activity that we do all the time.
10. A saying is a group of words with special meaning.

### IV. Sentence Construction Noncount nouns

Some nouns are not countable. They are not singular, and they are not plural, either. They are never used with the singular article a or an, and they don't usually take a plural -s ending. Noncount nouns take a singular verb. Study these examples:

meat Vegetarians don't eat meat. (no article)

One man's meat is another man's poison. (singular verb)

Make sentences with the groups of words below. The noncount noun in each group is underlined.

1. Peter / cook / meat / for hamburgers  
Peter cooks meat for hamburgers.
2. People / eat / food
3. Beef / come from / cows
4. Pork / come from / pigs
5. Coffee / come from / South America
6. Tea / come from / China

7. Some people / think / alcohol / poison
8. Some people / think / alcohol / very good
9. Some people / think / work / very good
10. Some people / think / work / poison

## V. Grammar Articles

Decide whether an article is needed in each blank. Write either a, an, or X (if no article is needed). The only single count nouns below are man, sandwich, and dinner.

\_\_\_\_\_ pelicans eat \_\_\_\_\_ fish, \_\_\_\_\_ vegetarians eat \_\_\_\_\_ vegetables, and \_\_\_\_\_ Americans eat \_\_\_\_\_ hamburgers. \_\_\_\_\_ people all over the world have \_\_\_\_\_ customs about \_\_\_\_\_ food. \_\_\_\_\_ man will eat almost any food when he is very hungry. He will eat \_\_\_\_\_ bread, \_\_\_\_\_ meat, \_\_\_\_\_ vegetables, or \_\_\_\_\_ sandwich. When I am hungry, I will eat anything.

## VI. Controlled Composition Dicto-comp

Your teacher will read the paragraph above three times. Listen carefully, but do not take notes. After the third reading, write the paragraph as well as you can from memory. Check your paper for articles and for subject-verb agreement.

## VII. Controlled Composition “You Are What You Eat”

The unit of writing that is longer than the sentence is the paragraph. To write a good paragraph, put together a group of sentences that all talk about the same topic. Each paragraph must have one clear theme. The beginning of a paragraph is indented.

Write a paragraph about your food habits. Indent the beginning of the paragraph. Answer all the questions below in good sentences to make a unified paragraph.

1. What kind of food do you eat?
2. What do you eat for breakfast?
3. What do you eat for dinner?
4. Do you follow any food laws?

Helpful vocabulary words:

Singular count nouns

a sandwich  
a hamburger  
vegetables  
beans

Plural count nouns

apples  
tomatoes  
coffee

Noncount nouns

bread    meat  
milk    cheese  
tea    fish  
salad    butter  
rice    soup

**VIII. Vocabulary and Spelling**    Word puzzle

This is a spelling game in which you must change the words by changing one letter at a time. To help you, there is a definition by each word.

Can you change the word food to the word pork?

1. f o o d    something to eat
2. g o o d    not bad
3. w o o d    comes from trees
4. w o r d    made of letters
5. w o r k    your job
6. f o r k    used for eating
7. p o r k    meat from a pig

Now change the word fire  
to mine.

1. f i r e    burns things
2. \_ \_ \_ \_    four plus one
3. \_ \_ \_ \_    Thin people eat  
to live. Fat  
people \_ \_ \_ \_  
to eat.
4. \_ \_ \_ \_    Pelicans \_ \_ \_ \_  
to eat fish.
5. \_ \_ \_ \_    a short name  
for Michael
6. \_ \_ \_ \_    Cats eat \_ \_ \_ \_

And what word will you make  
at the end of this puzzle?

1. read    You can \_ \_ \_ \_  
a book
2. \_ \_ \_ \_    true, genuine
3. \_ \_ \_ \_    breakfast, lunch,  
dinner
4. \_ \_ \_ \_    pork or beef
5. \_ \_ \_ \_    We \_ \_ \_ \_  
with oil  
or wood
6. \_ \_ \_ \_    hit or strike
7. \_ \_ \_ \_    a bird's

## THE KRAMERS' WOODPILE



Mary and Walter Kramer don't live in town. They have a small farmhouse in northern Vermont. Mr. Kramer built the farmhouse himself twenty years ago. It has an oil heater and a fireplace. Winters are very cold in Vermont, and oil is expensive. Sometimes they use the oil heater, but often they burn wood in the fireplace. They don't pay for the wood because they have trees on their own land. They cut down the trees and saw them into smaller pieces.

The Kramers enjoy working outside. They like to spend time together. Today they're working outside on an important job. They're cutting firewood for next winter. Mr. Kramer holds a log, and Mrs. Kramer uses an electric saw. Then they carry the logs back to the house. They put them on a woodpile next to the farmhouse. All winter they use the wood from the pile to keep warm. In this way they try to save a lot of money.

## I. Mechanics

A. Third person -s forms.

Follow the rules in chapter 2, section II and add the third person -s (or -es) to these verbs: live, have, use, burn, pay, cut, saw, show, hold, carry, put, try, save.

B. Review of capitalization and punctuation.

mr and mrs kramer dont live in town they live in a farmhouse in vermont its cold in the winter but it isnt expensive to heat the farmhouse they have many trees on their land so they usually burn wood today theyre cutting firewood for the winter next they will put the logs on a large woodpile by the farmhouse its not as expensive to live in the country but in the city it is everyone in the city has to pay for oil.

II. **Grammar** Review of the rules for articles with common nouns.

The rules for articles in English depend on whether you are talking about a noun in general or a specific noun. Below is a review of all the rules for articles that we have used in chapters 1 to 8.

1. Do not use an article before a person's name.
2. A single count noun must have an article. Use a or an when the noun is indefinite, general, or when you are mentioning it for the first time.
3. Plural and noncount nouns do not take an article when the noun is indefinite, general, or you are mentioning it for the first time.

<u>Single count nouns</u>	<u>Plural nouns</u>	<u>Noncount nouns</u>
a, an	(X)	(X)

Study the words in the list below. Then copy the paragraph. Write articles in the spaces where they are needed.

<u>Single count nouns</u>	<u>Plural nouns</u>	<u>Noncount nouns</u>
a farmhouse	trees	land
a fireplace	winters	money
a job	pieces	oil
a log	logs	time
an oil heater	summers	wood
a saw		work
a woodpile		



Mr. Kramer isn't rich, but he has many things. He has \_\_\_\_\_ land, \_\_\_\_\_ trees, \_\_\_\_\_ farmhouse, \_\_\_\_\_ oil heater, \_\_\_\_\_ oil, \_\_\_\_\_ fireplace, and \_\_\_\_\_ wood. He likes \_\_\_\_\_ work and he saves \_\_\_\_\_ money. He has \_\_\_\_\_ time to do \_\_\_\_\_ job well. He spends \_\_\_\_\_ winters and \_\_\_\_\_ summers with his wife in Vermont. They use \_\_\_\_\_ saw to cut \_\_\_\_\_ logs into \_\_\_\_\_ pieces, and then they put them in \_\_\_\_\_ woodpile.

III. **Grammar** Using the definite article the for second mention of nouns

We call a and an indefinite articles. They are used for nouns when the meaning is general, or indefinite. When we know the identity of a specific noun, we use the definite article, the. For instance, the second time we mention a noun in a paragraph, it is identified. Below are the rules for articles when you mention a noun the second time.

<u>Single count nouns</u> the	<u>Plural nouns</u> the	<u>Noncount nouns</u> the
----------------------------------	----------------------------	------------------------------

Write articles in the spaces below, where they are needed. Use a, an, or X (no article) the first time a noun is mentioned. Use the to refer to that noun the second time.

Mary and Walter Kramer have a farmhouse. He built the farmhouse himself. Today they're cutting \_\_\_\_\_ wood. They will put \_\_\_\_\_ wood into \_\_\_\_\_ woodpile. \_\_\_\_\_ woodpile is next to \_\_\_\_\_ farmhouse. \_\_\_\_\_ farmhouse has \_\_\_\_\_ oil heater and \_\_\_\_\_ fireplace. \_\_\_\_\_ oil heater is expensive, so they often use \_\_\_\_\_ fireplace. They have \_\_\_\_\_ trees on their land. They cut down \_\_\_\_\_ trees and saw them into small pieces. They like to save \_\_\_\_\_ money this way. They can use \_\_\_\_\_ money for other things.

IV. **Controlled Composition** Dicto-comp

Your teacher will read the text of the story above three times. Listen carefully, but do not take notes. After the third reading, write the paragraph as well as you can from memory. Check your paper for articles and for subject-verb agreement.

## V. Grammar Subject-verb agreement.

Each sentence below has a plural subject. Change the subject to the singular form. You will need an article (a or an) before each singular noun, and you will need an -s ending for the verb. Make all other necessary changes.

1. Oil heaters burn oil.
2. Fireplaces burn wood.
3. Farmhouses usually have fireplaces.
4. City houses usually have oil heaters.
5. Farmers work outside, on the land.
6. City people work inside, in offices, stores, or restaurants.
7. Farmers take wood from their own trees.
8. Women work as hard as men on a farm.
9. Farmers heat their houses with wood.
10. City people heat their houses with oil.

## VI. Controlled Composition. Responding to a picture

Mr. Hardy lives in Alaska. Look at the picture below to see Mr. Hardy. Rewrite the story "The Kramers' Woodpile" and change the word Kramers to Mr. Hardy. Make all other changes that are necessary.

New vocabulary:

The tool that he uses to cut wood is an ax.



## VII. Sentence Construction Words that are both nouns and verbs

Many words in English can be used both as nouns and as verbs with no change in spelling or pronunciation. Study the word lists below. Then write a sentence using each word as a noun. You will need to add a new verb and some other words to make the sentence complete.

Single count nouns: a cook, a burn, a cut, a pile, a fish, a visit, an order, an ache, a plan

Noncount nouns: work, heat, rain, snow, help

1. Pauline cooks in the Happy Day Restaurant. (be a cook)  
Pauline is a cook in the Happy Day Restaurant.
2. A careless cook often burns his fingers. (get a bum on)  
A careless cook often gets a burn on his fingers
3. A careless doctor often cuts his fingers. (get a cut)
4. Mr. Kramer piles the wood near the door. (make a pile of wood)
5. My grandfather fishes every Saturday afternoon. (catch a fish)
6. Sara visits her uncle in Venezuela every summer. (pay a visit to)
7. This customer always orders two hamburgers. (place an order for)
8. My head aches and I need an aspirin! (have a headache)
9. I work at the T.V. station. (work be at)
10. We heat with an oil stove. (get heat from)

## VIII. Vocabulary and Spelling Compound nouns

Some nouns in English are made of two separate nouns written together as one. Read the definition of each compound noun and write the word. Each singular count noun needs an article.

Example: a house that is located on a farm a farmhouse

- |                                     |                        |
|-------------------------------------|------------------------|
| 1. wood that is used for a fire     | 7. a killer of pain    |
| 2. a pile that is made of wood      | 8. an ache in the head |
| 3. a place where people make a fire | 9. the end of the week |
| 4. work that is done at home        | 10. light from the sun |
| 5. work to clean up the house       | 11. time in the day    |
| 6. a wife who stays in the house    | 12. time in the night  |

## IN THE CITY OR IN THE SUBURBS

Howard Allen and David Foster have an insurance company, and they employ 2000 people. Their company is growing fast, so they need a new office building. Mr. Allen wants to build in the city, but Mr. Foster likes the suburbs.

Allen: Well, Dave. Good news. I have an offer from the old Northeastern Bank Company. They want to sell us their old building for \$50 million. You know their location; it's in the center of the city!

Foster: Wait a minute, Howard. Land is really expensive in the city. There is not enough room for us in that building, and there is no room for growth. Isn't there any other location we can use?

Allen: What do you have in mind?

Foster: You know, there is a lot of room outside the city. Land is cheaper there. In the suburbs there is no pollution, there is little traffic, and there is no noise. There's a lot of room for parking cars. Our workers don't like to drive into the city every day.

Allen: That's true. In the city there are a lot of problems. But what about the advantages? There are parks, museums, restaurants, theaters, stores...

Foster: Our workers have no time to use those things during the week. And by the weekend, they're sick of driving. I have an offer here for office space in the new industrial park. Ten million dollars. There are lots of offices, so we can continue growing. Is there any reason to say no?

Allen: Great! I'm sick of the city myself. Now I can enjoy it on weekends.



**I. Grammar** Count and noncount nouns with articles

Study the words in the list below. Then copy the paragraph. Write articles in the spaces where they are needed.

Singular count nouns

an insurance company  
a building  
an offer  
a location  
an office  
a reason  
a place

Plural nouns

people  
cars  
workers  
problems  
parks  
museums  
restaurants  
theaters  
stores  
weekends

Noncount nouns

insurance  
land  
room  
pollution  
traffic  
noise  
office space  
time

Mr. Allen and Mr. Foster want \_\_\_\_\_ good location for \_\_\_\_\_ new office building. \_\_\_\_\_ location should be safe and quiet. They have \_\_\_\_\_ offer from \_\_\_\_\_ Northeastern Bank Company, but \_\_\_\_\_ offer is very expensive. Mr. Allen likes \_\_\_\_\_ cities because there are \_\_\_\_\_ parks, \_\_\_\_\_ museums, \_\_\_\_\_ restaurants, \_\_\_\_\_ theaters, and \_\_\_\_\_ stores there. Mr. Foster says that in \_\_\_\_\_ cities there is \_\_\_\_\_ pollution, \_\_\_\_\_ traffic, and \_\_\_\_\_ noise. \_\_\_\_\_ theaters and \_\_\_\_\_ stores are no good if there isn't \_\_\_\_\_ time to visit them. Finally they decide on \_\_\_\_\_ good place. \_\_\_\_\_ office building will be in \_\_\_\_\_ Suburban Industrial Park. \_\_\_\_\_ place is just right for \_\_\_\_\_ new office building.

**II. Controlled Composition** Dicto-comp

Your teacher will read the paragraph above three times. Listen carefully, but do not take notes. After the third reading, write the paragraph as well as you can from memory. Check your paper for articles and for subject-verb agreement.

**III. Sentence Construction** Statements with There is and There are

In one sentence pattern in English, the real subject of the sentence does not hold the first position in the sentence; the word there acts as a substitute subject, and the real subject comes after the verb to be. Study

the model sentences below. Notice the different patterns for singular count nouns, plural nouns, and noncount nouns.

There + Verb + Quantifier + Noun Phrase + Adverb Phrase  
(Real subject)

Singular Count	There is	(a) an no	office building on Grand Avenue.
Plural Count	There are	lots of a lot of many some few no	office buildings in the city.
Noncount	There is	lots of a lot of much some little no	noise in the city.

Make a sentence with each group of words below. Use the correct verb and choose a quantifier for each sentence.

1. people / city                    There are lots of people in the city.
2. people / country                There are few people in the country.
3. pollution / country              There is no pollution in the country.
4. pollution / city                  There is a lot of pollution in the city.
5. room / city
6. room / country
7. good location / city
8. good location / country
9. cars / city
10. cars / country
11. good reason to build / city
12. good reasons to build / country
13. restaurants / city
14. restaurants / country
15. problems / city
16. problems / country

**IV. Sentence Construction** Questions with Is there and Are there

Notice that the patterns for questions are slightly different. The verb comes first, before there. Use the word any in a question if you have no idea what the answer will be. Use a more definite quantifier if you already have an idea about the answer.

Examples: office buildings / suburbs

Are there many office buildings in the suburbs?

(I know there are some, but I don't know how many there are.)

problems / suburbs

Are there any problems in the suburbs?

(I don't know if there are problems or not.)

Verb + There + Quantifier + Noun Phrase + Adverb Phrase  
(Real subject)

Singular Count	Is there	(a) an	office building on Grand Avenue?
Plural Count	Are there	lots of a lot of many any	office buildings on Grand Avenue?
Noncount	Is there	lots of a lot of much any	noise in the city?

Make questions with each group of words below. Use the correct verb and choose a quantifier for each sentence.

1. office space / city
2. office space / suburbs
3. pollution / city
4. pollution / suburbs
5. noise / city
6. noise / suburbs
7. insurance company / suburbs

8. office building / suburbs
9. cars / suburbs
10. cars / city
11. restaurants / city
12. restaurants / suburbs
13. stores / suburbs
14. good location / suburbs

#### V. **Grammar** Word order with adverb phrases

Study the two sentences below, and notice the position of the adverb phrases. Rewrite each of the following sentences, putting the adverb phrase first.

There is a lot of rain near the ocean.

Near the ocean there is a lot of rain.

1. There is a lot of pollution in New York.
2. There is a lot of land in Alaska.
3. There is a lot of traffic in Tokyo.
4. There are many insurance companies in London.
5. There is no time for shopping on week days.
6. There is lots of time for museums on the weekends.
7. There's no space for parking on the street.
8. There are a lot of beaches in Venezuela.
9. There are many Chinese restaurants in San Francisco.
10. There's very little noise in the country.

#### VI. **Grammar** Sentence combining review

Combine each pair of sentences by using and...too, and...either, or but. Leave out the main verb and all the other information from the second sentence that is repetitious.

Mr. Allen wants to build in the city.

Mr. Foster doesn't want to build in the city.

Mr. Allen wants to build in the city, but Mr. Foster doesn't.

1. The Northeastern Bank Company is in the city.  
The industrial park isn't in the city.
2. Our building doesn't have enough office space.  
The Northeastern Bank office building doesn't have enough office space.



3. Land is expensive in the city.  
In the suburbs land isn't expensive.
4. The city has a lot of pollution.  
The suburbs doesn't have a lot of pollution.
5. The city has some advantages.  
The suburbs has some advantages.
6. The city has many parks, museums, restaurants, theaters, and stores.  
The suburbs doesn't have many parks, museums, restaurants, theaters, or stores.
7. The workers have no time for museums during the week.  
On the weekend the workers have time for museums.
8. The workers are sick of driving.  
I am sick of driving.
9. The workers enjoy the weekends.  
The employers enjoy the weekends.

## VII. **Controlled Composition** Incomplete letter

The word memo is short for memorandum. It is a short message or letter that people send to each other at work. The employers at the Allen-Foster Insurance Company want to know the workers' opinions about the city and the suburbs. They are planning a new office building, and they want the workers to be happy. Pretend that you are a worker at the company and write a short composition about your opinions.

**ALLEN-FOSTER INSURANCE COMPANY**  
"Where your happiness is our success"

**MEMO**

To: Company Employees  
From: Howard Allen and David Foster  
Re: New Office Building

Please write us a short note about your opinion: Which is better for our new office building, the city or the suburbs? We want you to be happy. Choose a location and give us all your reasons.

Thank you.

March 18, 19\_\_\_\_\_

Dear Mr. Allen and Mr. Foster,

You are very kind to ask our opinions about the new office building. I like to work in the \_\_\_\_\_, for there (is/are) \_\_\_\_\_ . Also, there (is/are) \_\_\_\_\_.

I don't like to work in the \_\_\_\_\_, because there (is/are) \_\_\_\_\_ . Besides this, there (is/are) \_\_\_\_\_.

For these reasons, please build the new office building in the \_\_\_\_\_.

Thank you.

Sincerely,

\_\_\_\_\_

### VIII. Vocabulary and Spelling Compound nouns

Some two-word combinations in English are so common that they are almost like a single word, even though they are not written together. Read the definition of each two-word combination and write the words as they are used together. Each singular count noun needs an article.

Example: a dance that is done by eight people in a square  
a square dance

1. a heater that burns oil
2. customs about food
3. the season when farmers can be growing food
4. winds that come off the ocean to the land
5. a station which broadcasts T.V. programs
6. a story that is written in the newspaper
7. a pal who writes letters to you with paper and pen
8. the pharmacist who works as the head of the department
9. a company that sells insurance
10. a building where many people have an office
11. a park that is used for industrial buildings
12. space for each person to work in an office

# RIDDLES

A: What is full of holes, and holds water?

B: A sponge.

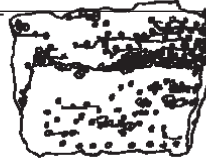

A: Who shaves many times a day, and still has a beard?

B: A barber.

A: What is full at night and empty in the daytime?

B: A bed.

A: When is a piece of wood like a king?

B: When it is a ruler.



A: When does water stop running downhill?

B: When it gets to the bottom.



A: Where was Bill when the lights went out?

B: In the dark.



A: Why does a cow wear a bell?

B: Because its horns don't work.

A: Which hand do you use to stir soup—the right hand or the left hand?

B: Neither one. I use a spoon.

A: How do you catch elephants?

B: Hide in the grass and make a noise like a peanut.

A: How many lions can you put in an empty cage?

B: One. After that, the cage is not empty.

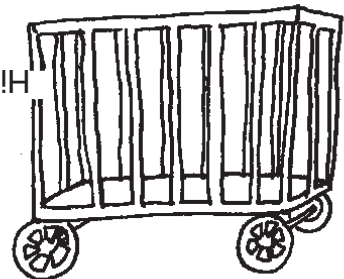

I. **Grammar** Review of verbs in yes-no questions

Copy the questions below and add a verb to each question.  
You may add do, does, or a form of the verb to be.

1. \_\_\_\_\_ a sponge full of holes?
2. \_\_\_\_\_ a sponge hold water?
3. \_\_\_\_\_ a barber shave many times a day?
4. \_\_\_\_\_ a barber have a beard?
5. \_\_\_\_\_ a bed full at night?
6. \_\_\_\_\_ a bed empty in the daytime?
7. \_\_\_\_\_ water run downhill?
8. \_\_\_\_\_ a cow wear a bell?
9. \_\_\_\_\_ you use your right hand to stir soup?
10. \_\_\_\_\_ you catch elephants?
11. \_\_\_\_\_ a peanut make a noise?
12. \_\_\_\_\_ the cage empty?

II. **Grammar** Information questions

A. Questions with when, where, why, and how. To begin a question with these words, use verb-subject word order, and place the question word before the verb.

	<u>Question word</u>	<u>Verb</u>	<u>Subject</u>	<u>Complement</u>
Old pattern:		Is	a piece of wood	like a king?
New pattern:	When	is	a piece of wood	like a king?

Rewrite the questions below, turning them into information questions.  
Add a question word before the verb.

1. Does a cow wear a bell? (Why)
2. Does water stop running downhill? (When)
3. Do you catch elephants? (How)
4. Does a sponge hold water? (How)
5. Does a barber shave many times a day? (Why)
6. Is a bed full? (When)
7. Is a bed empty? (When)
8. Do you use your hand to stir soup? (Why)
9. Is the cage empty? (When)
10. Is Bill standing? (Where)

B. Questions with who, what, and which. Who, what and which can act as the subject of the sentence, so there is no need for an extra auxiliary verb. Normal subject-verb word order is used. Simply replace the subject with who (for people), what (for things) or which + a noun. You will write a riddle for each problem.

Example: A sponge is full of holes and holds water.  
What is full of holes and holds water?

1. A barber shaves many times a day and still has a beard.
2. A bed is full at night and empty in the daytime.
3. A night watchman earns a living without a day's work.
4. A road runs up the hill and down the hill, but always stands still.
5. A secret is too much for one, enough for two, but nothing at all for three.
6. A keyhole goes through a door, but never goes in or comes out.

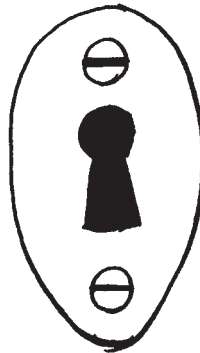



7. A donkey is the most difficult key to turn. (Use which key)
8. A man walks on four legs in the morning, on two legs at noon, and on three legs in the evening.

### III. Sentence Construction      Concentration

This is a game you can play with another person. Cut squares of paper to fit over each box below. Cover each box with a square of paper. Have a pencil and paper ready to write sentences.

The first player turns over two squares. He reads the words in the boxes. If they make a riddle and an answer, he writes both parts on his paper. He leaves the boxes uncovered. If the sentences do not go together to make a riddle and its answer, he covers them again. (Remember what is under each square of paper!) The second player takes his turn. Continue playing until all the squares are uncovered.

The player with the most riddles on his paper is the winner.

When do you throw lettuce and tomatoes around the kitchen?	At the bottom.	What is full in the day time and empty at night?	Because their heads are so far away from their bodies.
When they beat the eggs and whip the cream.	Who raises things with out lifting them?	How do you catch an elephant in the jungle?	A farmer.
When are cooks mean?	A pair of boots. 	Where is the Pacific Ocean the deepest?	When you want to toss a salad.
Which burns longer—a black candle or a white candle?	Why do giraffes have such long necks? 	By the smell of peanuts on its breath.	Neither one. Both burn shorter. 

#### IV. Grammar Possessives with things

You have learned to show possession by adding 's or s' to a person's name. For instance, John has hands→John's hands. However, when the hands belong to an object—such as a clock—we do not use 's. We use the preposition of to show possession: the hands of the clock.

Many objects are compared to people so that we say objects have hands, eyes, mouths, tongues, and heads. Use the structure the (noun) of the (noun) in each problem below.

Example: We say that a clock has hands, the hands of the clock

1. We say that a needle has an eye.
2. We say that a table has legs.



3. We say that a shoe has a tongue.
4. We say that a nail has a head.
5. We say that a comb has teeth.
6. We say that a river has a bed.
7. We say that a clock has a face.
8. We say that a bed has a foot.
9. We say that a jar has a mouth.
10. We say that a jungle has a heart.

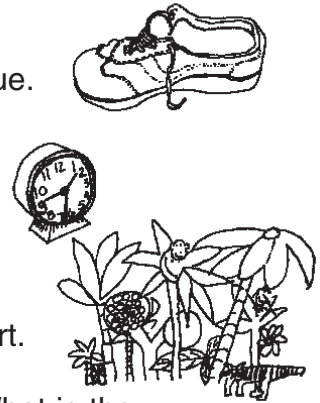

**V. Sentence Construction** Here is the answer. What is the question?

Below are the answers to some riddles. Write a good riddle before each answer. If you need help with vocabulary, look at the words in parentheses.

Example: (hands, cannot write) What has hands but cannot write?

A clock.

1. (a head, cannot think) \_\_\_\_\_  
A nail.
2. (teeth, cannot bite) \_\_\_\_\_  
A comb.
3. (legs, cannot walk) \_\_\_\_\_  
A table.
4. (an eye, cannot see) \_\_\_\_\_  
A needle.
5. (a tongue, cannot speak) \_\_\_\_\_  
A shoe.
6. (a bed, cannot sleep) \_\_\_\_\_  
A river.
7. (a heart, cannot love) \_\_\_\_\_  
A jungle.
8. (a mouth, cannot eat) \_\_\_\_\_  
A jar.
9. (a face, cannot smile) \_\_\_\_\_  
A clock.
10. (a foot, cannot walk) \_\_\_\_\_  
A bed.

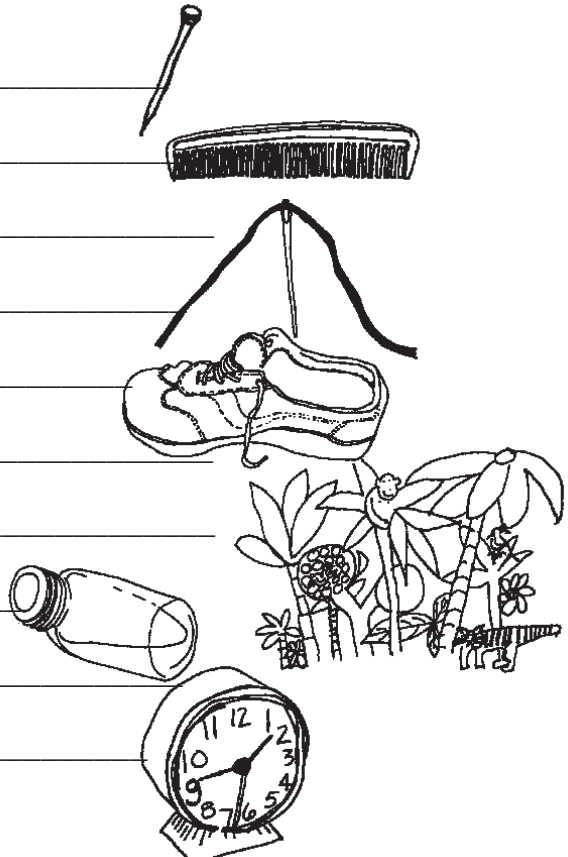

## VI. Grammar Choosing prepositions

Look at the meanings of the prepositions below. Then copy the sentences, choosing a preposition to fill each blank.

of—shows possession

in—inside, within

from—shows origin or  
nationality

on—resting on the top  
surface

1. Ernie Anderson is \_\_\_\_\_ the United States. He is American.
2. The head \_\_\_\_\_ a nail is very flat.
3. I think that you hit the nail \_\_\_\_\_ the head.
4. A cook works \_\_\_\_\_ a restaurant.
5. Put another hamburger \_\_\_\_\_ the grill, please.
6. We have many trees \_\_\_\_\_ our land.
7. My cat likes to sit at the foot \_\_\_\_\_ the bed.
8. There is more noise \_\_\_\_\_ the city than \_\_\_\_\_ the country.
9. Put the logs \_\_\_\_\_ the woodpile.
10. Roberto comes \_\_\_\_\_ Caracas, Venezuela.

## VII. Controlled Composition Choosing relevant information

Good writers choose information that is important for their topic. Choose sentences from the list below to write about each of the topics. Then organize a paragraph with sentences about the topic. Each paragraph will have four sentences. The topics are: “Water” and “A Sponge.”

### Model paragraph

#### “Water”

Water runs downhill. Gravity pulls water down. The water runs from a high place to a low place. When it gets to the bottom, it stops.

1. Water runs downhill.
2. A sponge is full of holes.
3. Gravity pulls water down.
4. A dry sponge holds air.
5. The water runs from a high place to a low place.
6. When it gets to the bottom, it stops.
7. A wet sponge holds water.
8. A wet sponge is heavier than a dry sponge.



## VIII. Vocabulary and Spelling Puns

Some riddles are funny because they are puns. Puns are made with words that have double meanings. A pun doesn't make sense until you know both meanings of the word. Read the riddles below and then write the two meanings of each underlined word.

Example: A. When is a car not a car?

B. When it is turning into a driveway. (4,7)

Turning into means turning to enter and becoming, transforming.

A. When did the blind man see?

B. When he picked up his hammer and saw.

A. What has four legs and flies?

B. A picnic table.

A. When is a piece of wood like a king?

B. When it is a ruler.

A. Why does a cow wear a bell?

B. Because its horns don't work.

A. Who raises things without lifting them?

B. A farmer.

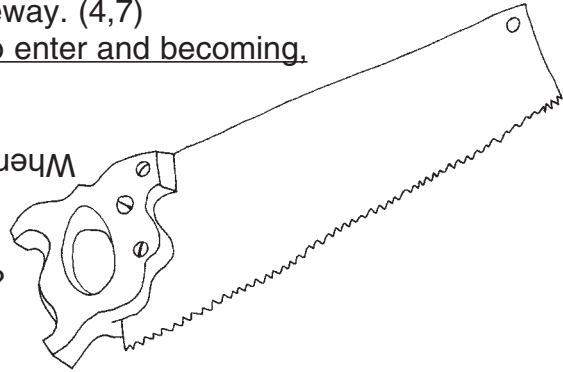

1. hard, curved bones on the outside of a cow's head
2. moves in the air
3. a tool for cutting wood
4. turning to enter
5. a loud instrument for making noise
6. insects that disturb picnics
7. becoming, transforming
8. past of see
9. to grow vegetables
10. a straight piece of wood for measuring
11. the leader of a country
12. to elevate, to move something higher

Some puns are made with homonyms. Homonyms are words that sound the same but are spelled differently. These riddles and puns are not so funny in writing. You need to say them out loud in order to understand them completely.

Read these riddles out loud and then write the two meanings of each underlined word.

Example: A. What is black and white and read all over?  
B. A newspaper.

The two meanings are read and red. (12,13)

- A. Why don't people ever become hungry in the Sahara desert?
- B. Because of the sand which is there.
- A. Where is a sneeze usually pointed?
- B. Achoo!
- A. How do trains hear?
- B. Through their engineers.
- A. When is a sailor not a sailor?
- B. When he is ashore.
- A. Where does the sheep get its hair cut?
- B. At the baa-baa shop.
- A. How do you spell "blind giant"?
- B. bind gant. You spell it that way because a blind giant has no eyes.
- A. When is a door not a door?
- B. When it is ajar.
- A. Where were the first potatoes fried?
- B. In Greece.

- 1. ashore: on the land, not on the ship
- 2. engineers: the drivers of trains
- 3. a jar: a round glass container with a wide mouth
- 4. sand which is: three words that sound like the word sandwiches
- 5. a shore: the part of the land that meets the ocean
- 6. baa-baa: the sound that a sheep makes
- 7. Greece: a country in southern Europe
- 8. barber: the man who cuts hair and shaves beards
- 9. ajar: open a little bit
- 10. engine ears: a nonsense phrase, meaning the ears of an engine
- 11. grease: oil or fat for frying foods
- 12. read: past of read
- 13. red: a color
- 14. sandwiches: a kind of food made with bread and a filling
- 15. achoo: the sound of a sneeze
- 16. eyes: the part of the face that sees
- 17. at you: two words that sound like achoo!
- 18. l's: plural for l, a letter in the alphabet that sounds like eye

# CROWDING



Look around you—what do you see? What do you hear? What do you smell? If you live in a city, you probably see many people. You hear the noise of traffic, and you smell the pollution from cars and factories.

We are entering a new time in the history of the world. Before this, most people were farmers. They lived in the country. Now many people are leaving the farms and moving into the cities. They are looking for jobs. The cities are growing very quickly.

Most cities are very crowded. People are driving more cars, burning more fuel, using more water, eating more food, making more garbage, and producing more things in factories than ever before. Life is becoming difficult.

Some governments are trying to plan for the future. They are building new roads, putting up new houses, looking for more water, and limiting growth in certain areas. Still, city planners are getting worried. People are crowding into the cities faster than the cities can take them. The cities are running out of room. What is the answer to this problem?

## I. **Mechanics** Using commas in a series

We use a comma between all the members of a list, or a series.

We need eggs, cheese, milk, and bread.

Copy the sentences, and make all the corrections that are necessary. Use capital letters when they are needed.

1. what do you see hear feel and smell
2. i see cars people houses stores and factories
3. the largest cities in the world are new york city mexico city tokyo los angeles shanghai buenos aires paris and peking
4. people are using more food fuel water and air
5. they are planning cities building roads finding water putting up houses and limiting growth
6. the growth of cities is a problem in europe africa asia north america and south america
7. what are we doing about the traffic the noise the pollution and the crowding
8. do these problems have an answer

## II. **Grammar** Spelling -ing verb forms

The present progressive tense is a combination of two verbs. The auxiliary is a form of be, and the main verb takes an -ing ending. The spelling rules depend on the order of vowel (V) and consonants (C) in the verb.

1. Verbs that end with e drop the e and add -ing. Write the forms below with the correct spelling.

She is writing. (write, drive, live, come, move)

We are dancing. (dance, shave, hide, smile, hope)

2. Verbs that end in a vowel followed by a double consonant (VCC) or in a double vowel followed by a consonant (VVC) simply add -ing. Write the forms below with the correct spelling.

He is cooking. (cook, wait, help, count, sleep, think)

They are working. (work, eat, read, watch, finish, walk)

3. Verbs that end in a single stressed vowel followed by a single consonant (VC) must add another consonant before adding -ing. Write the forms below with the correct spelling.

I am swimming. (swim, win, plan, sit, stop)  
You are cutting. (cut, run, dig, shop, get up)

(Notice that verbs with the stress before the last syllable do not follow this pattern. They do not take a double consonant, vísit → visiting, énter → centering, límit → limiting)

(A few more exceptions to the rule of the double consonant are verbs that end in w, x, or y. They do not double. Write the forms below with the correct spelling.)

He is buying. (buy, relax, grow)  
We are playing. (play, fix, pay, saw)

4. Verbs that end in ie change the ie to y and add -ing. Verbs that end in other vowels simple take -ing.

She is dying. (die, lie, tie, go, see)

### III. Grammar Subject-verb agreement + present continuous

Rewrite the paragraphs below, adding the correct form of the verbs. The verb be must agree with the subject. The main verb takes -ing.

Many farm people are coming into the cities, (come) They \_\_\_\_\_ their farms for a life in the city. (leave) They \_\_\_\_\_ for jobs, houses, and a new set of friends. (look for) The cities \_\_\_\_\_ very crowded. (become) The government \_\_\_\_\_ to help the people, but the problem is too serious, (try) The head city planner \_\_\_\_\_ worried about the future. (get)

“We \_\_\_\_\_ not \_\_\_\_\_ new houses fast enough,” he says. (build) “The city \_\_\_\_\_ out of room, water, jobs, and houses. (run out) We \_\_\_\_\_ about a limit on growth. (think about) Our big cities \_\_\_\_\_ too fast. (grow) Few farmers \_\_\_\_\_ grain and vegetables for us to eat. (raise) This situation \_\_\_\_\_ the whole country in danger.” (put)

### IV. Controlled Composition Dicto-comp

Your teacher will read the paragraph below three times. Listen carefully, but do not take notes. After the third reading, write the paragraph as well as you can from memory.

Some governments are trying to plan for the future. They are building new roads, putting up new houses, finding more water, and limiting growth in certain areas. Still, city planners are getting worried. People are crowding into the cities faster than the cities can take them. The cities are running out of room. What is the answer to this problem?

**V. Grammar** Using the definite article the before prepositional phrases.

The general rule for the definite article is that we use the when we know the identity of the noun. We often know which particular noun is meant if there is a prepositional phrase to define it.

Example: Every person has X problems. (No article because “problems” is a very general word here.) The problems of cities are serious. (Here we use the because we know which problems we are talking about. They are the problems of cities.)

Write these phrases. Add the at the beginning.

1. \_\_\_\_\_ growth of cities
2. \_\_\_\_\_ smell of pollution
3. \_\_\_\_\_ noise of the crowd
4. \_\_\_\_\_ pollution from cars
5. \_\_\_\_\_ cars in the street
6. \_\_\_\_\_ governments of South America
7. \_\_\_\_\_ products from our factories
8. \_\_\_\_\_ noise from factories
9. \_\_\_\_\_ sound of a horn
10. \_\_\_\_\_ history of the world

**VI. Sentence Construction** Making questions about topics

There is usually more than one way to ask a question. For each topic below you may ask a question at least two ways. Use the vocabulary that is given and write two questions for each topic. You will need to add auxiliary verbs.

1. moving  
where / farmers / moving Where are farmers moving?  
farmers / moving / to the city  
Are farmers moving to the city?

2. looking for jobs  
what / people / looking for  
people / looking for / jobs
3. growing  
how fast / cities / growing  
cities / growing / very quickly
4. building  
what / governments / building  
governments / building / new roads and houses
5. looking for water  
what / governments / looking for  
governments / looking for / water
6. feeling  
how / city planners / feeling  
city planners / feeling / worried

## VII. **Controlled Composition** Incomplete dialog

Below are the answers to some questions. Write a good question before each answer. When you finish, you will have a dialog that you can act out with a partner.

### “An Interview with a City Planner”

Reporter: Are you Roger Collins?

Planner: Yes, I am. I’m Roger Collins. Are you the reporter from the Chicago Press?

Reporter: Yes, I’m Kent Clark. \_\_\_\_\_ ?

Planner: Yes, it’s a good time to talk. Normally I am a very busy man, but right now I’m just killing time.

Reporter: \_\_\_\_\_ ?

Planner: I’m waiting for a phone call about a new air pollution rule from the government office. I’m very worried.

Reporter: \_\_\_\_\_ ?

Planner: Because the phone call is late. It’s an important call. We need a new pollution rule.

Reporter: \_\_\_\_\_ ?

Planner: Because the air in the city is very dirty. It’s a dangerous

situation for old people and for children. We are making plans to move some of the companies into the country.

Reporter: \_\_\_\_\_?

Planner: Some companies agree, but others don't. This new rule will make our job easier.

Reporter: \_\_\_\_\_?

Planner: Yes, there are several companies in the country now. The Allen-Foster Insurance Company, for example, is in the country. Their move is a great success.

Reporter: \_\_\_\_\_?

Planner: Well, no, not really. An insurance company is actually quite clean. But the Allen-Foster Company is setting a good example, and their workers are very happy now.

Reporter: \_\_\_\_\_?

Planner: These moves help the city in many ways. First, we need to limit growth. Second, we need to cut pollution. Third, we need to limit traffic in the city.

Reporter: \_\_\_\_\_?

Planner: Yes, we do. We have other plans to help the city. For example, with water...

Reporter: \_\_\_\_\_?

Planner: Yes, we are. We're looking for water. And houses...

Reporter: \_\_\_\_\_?

Planner: Yes, we are. We're building 200 new houses. Excuse me, my phone call is here.

Reporter: Good-bye, and thank you for the interview.

### VIII. **Controlled Composition** Choosing relevant information

Choose sentences from the list below and write two separate paragraphs. Choose relevant information and organize the sentences into a clear order. The topics are: "Crowding" and "Pollution." Each paragraph will have six sentences.

1. First, young people from the country are looking for better jobs in the city.
2. Second, many people think that city life is more interesting.
3. Farmers work very hard, and they don't earn much money.
4. There are many kinds of pollution.



5. Many people throw garbage on the ground.
6. Why are so many people moving into the city?
7. There are two reasons.
8. Air pollution comes from cars and factories.
9. There are more theaters, parks, and shops in the city.
10. Water pollution comes from factories, too.
11. Noise pollution comes from car horns, factories, trains, and crowds of people.
12. Garbage is a kind of pollution.

## CORNER STORES AND SUPERMARKETS

The corner grocery store was an American tradition, but now it is dying out. In older times there was a small grocery store in every neighborhood. Every day the housewife went to the store to buy milk, fresh bread, and other food. Now most corner stores are gone, or they are closing. They are losing business to large supermarkets.



Supermarkets are bigger than corner stores. The corner store is a family business, a “Ma and Pa” operation. Supermarkets like Shop-Rite or Super Valu employ more people. They are newer, more modern, and they stay open longer. They have a greater variety of products. They buy larger amounts of food, so they can offer lower prices. Most supermarkets are in large shopping centers. They may be one, two, or ten miles from people’s homes. Now housewives shop less often. They go to the supermarket once or twice a week.

Many people miss the old corner store. It was smaller, friendlier, and closer to home. But small businesses can’t compete with large companies.



## I. Mechanics

### A. Spelling of -ing forms

Follow the rules in chapter 12, section II and add -ing to these verbs: die, close, lose, employ, stay, buy, offer, shop, miss, compete

### B. Capital letters for the names of companies and stores

The names of companies and stores begin with capital letters:

Super-Valu    Shop Rite    Bob and Marsha's Grocery

Acronyms and abbreviations use capital letters, too.

UNESCO    IBM    IGA

Copy the sentences, and make all the corrections that are necessary.

1. bob and marsha s grocery is a ma and pa operation
2. their store belongs to the i g a, the independent grocers association
3. they don t belong to a large company like shop rite or super valu
4. the i g a helps them order canned food
5. bob and marsha buy fruits and vegetables from local farmers like oscar lindstrom
6. there s also a special part of the store for mexican food
7. bob and marsha s is on midway avenue and river drive
8. there s a shop rite store one mile away
9. the shop rite store sells food from china lebanon mexico and Italy
10. shop rite and super valu sell a greater variety of food at cheaper prices

## II. Grammar    Comparison of adjectives

English has three degrees of comparison for adjectives. They are the positive, the comparative, and the superlative. Study these examples:

Spaghetti is cheap. (positive)

Bread is cheaper. (comparative)

Rice is the cheapest. (superlative)

Fish is expensive. (positive)

Pork is more expensive. (comparative)

Beef is the most expensive. (superlative)

The form and spelling of the comparison depends on the number of syllables and the order of vowels (V) and consonants (C) of the adjective. Below are the rules for comparison of adjectives.

1. Most adjectives of one syllable take -er and -est endings. (If the adjective ends in e already, simply add r or st.) You must use the definite article, the, before superlatives. Write the forms below with the correct spelling.

<u>Positive</u>	<u>Comparative</u>	<u>Superlative</u>
small	smaller	the smallest
close	closer	the closest
long		
large		
high		
hard		
cheap		
great		
fast		
strange		
loud		
cold		

2. One-syllable adjectives that end in a single stressed vowel followed by a single consonant (VC) must add another consonant before adding -er or -est. Write the forms below with the correct spelling.

<u>Positive</u>	<u>Comparative</u>	<u>Superlative</u>
hot	hotter	the hottest
big		
wet		
fat		
thin		
glad		
sad		
red		

(There are some exceptions to the rule of the double consonant. Adjectives that end in w, x, or y do not double. Write the forms below with the correct spelling.)

Positive

slow  
new  
low  
gray

Comparative

slower

Superlative

the slowest

3. Two-syllable adjectives that end in -y can take -er and -est endings, but the y changes to i before the ending. Write the forms below with the correct spelling.

Positive

hungry  
busy  
early  
friendly  
noisy  
dirty

Comparative

hungrier

Superlative

the hungriest

4. All other adjectives of two or more syllables take the words more and the most for comparisons. Write the forms below with the correct spelling.

Positive

important  
delicious  
pleasant  
expensive  
crowded  
modem  
difficult  
dangerous  
polluted

Comparative

more important

Superlative

the most important

### III. **Sentence Construction** Making comparisons

Use the vocabulary that is given and make a comparison between the two nouns. Add a verb and the word than.

Example: supermarkets / corner stores / big  
Supermarkets are bigger than corner stores.

1. supermarkets / corner stores / new

2. supermarkets / corner stores / modern
3. the working hours of supermarkets / the working hours of corner stores / long
4. the prices at supermarkets / the prices at corner stores / low
5. corner stores / supermarkets / friendly
6. corner stores / supermarkets / close to home
7. fresh bread / old bread / soft
8. fresh vegetables / canned vegetables / delicious
9. supermarkets / corner stores / crowded
10. supermarkets / corner stores / noisy and busy

#### IV. **Controlled Composition** Choosing relevant information

Choose sentences from the list below and write two separate paragraphs. Choose relevant information and organize the sentences into a clear order. The topics are: "I Hate Supermarkets" and "I Like Supermarkets." Each paragraph will have eight sentences.

1. I really don't like shopping in supermarkets.
2. Supermarkets are too big, and I can't find anything there.
3. The clerks are unfriendly.
4. I am so happy to live near a supermarket!
5. I can find food from Italy, Mexico, China, and Japan.
6. They are noisy, busy, crowded places.
7. They are light, clean, large, modern stores.
8. Nobody helps me.
9. The prices are low, and the food is fresh.
10. The supermarket has all the kinds of food that I need.
11. The variety of food is so great that I can't choose.
12. I have to wait in line a long time to pay.
13. Sometimes the store serves free coffee and cake.
14. My supermarket is open from 7:00 in the morning until midnight.
15. I always spend too much money, and I get a headache.
16. My friends from other parts of the city shop there, too.

#### V. **Controlled Composition** Dicto-comp

Your teacher will read the paragraph below three times. Listen carefully, but do not take notes. After the third reading, write the paragraph as well as you can from memory.

The corner grocery store was an American tradition, but now it is dying out. Corner stores are losing business to large supermarkets. Supermarkets are bigger than corner stores. They are newer, more modern, and they stay open longer. They have a greater variety of products. They buy larger amounts of food, so they can offer lower prices. Many people miss the old corner store. It was smaller, friendlier, and closer to home. But small businesses can't compete with large companies.

**VI. Grammar** Using the with a specific group or a specific kind: plurals and noncount nouns

The definite article the is used to show a specific group or a specific kind of thing. When no article is used with plurals and with noncount nouns, then the meaning of the noun is general and very inclusive. For example, look at this sentence: \_\_\_\_\_ Clerks are unfriendly. This means that all clerks are unfriendly. Compare this sentence: The clerks at Ted's Grocery are unfriendly. The second sentence refers to a specific group of clerks.

Copy the paragraph and write articles in the spaces where they are needed.

Bob and Marsha's Grocery isn't \_\_\_\_\_ biggest store in the city, but it is \_\_\_\_\_ friendliest. Most store owners don't know \_\_\_\_\_ names of their customers, but Bob and Marsha know \_\_\_\_\_ name of every customer in their store. Marsha knows \_\_\_\_\_ likes and \_\_\_\_\_ dislikes of all her customers. For example, I like \_\_\_\_\_ tea. I don't like \_\_\_\_\_ coffee. I asked Marsha, "Do you have \_\_\_\_\_ tea?" She asked me, "Do you like \_\_\_\_\_ tea from England or \_\_\_\_\_ tea from China?" I answered, "I like \_\_\_\_\_ tea from India, and I like \_\_\_\_\_ tea from China, but I think that \_\_\_\_\_ tea from Japan is \_\_\_\_\_ best tea." Now she always has \_\_\_\_\_ tea that I like. They are \_\_\_\_\_ friendliest people in town, and their store is \_\_\_\_\_ busiest!

**VII. Controlled Composition** Variety in sentence types

Good writers use some short, simple sentences and some longer sentences. Rewrite the paragraphs and vary the length of the sentences. Make some longer, and change the word order in some. Combine some sentences with and, but, so, and or.

Food habits are changing in America. Some people are trying vegetarian food. They don't like meat. They eat other things. This kind of diet doesn't include meat. It is healthy anyway. Vegetarians have many food choices for protein. They can eat eggs. They can eat cheese.

Many Americans are trying food from other countries. People come to America from many places. There is a great variety of food in the United States. Food habits are part of a national culture. People bring their food habits with them. Soon people try the food of other countries. It appears in all the grocery stores. People eat this food in restaurants. They learn to cook it at home.

### VIII. Vocabulary and Spelling Crossword puzzle

The ending -er can be added to a verb to make a noun. It means, "the person or the thing that does..." For example, a helper is a person who helps, and a freezer is a machine that freezes food.

Add -er to each verb in the lists below. Use these new words to fill in the crossword puzzle.

(Verbs that end with a single stressed vowel followed by a single consonant—VC—must double the consonant before adding -er. Verbs that end in y change the y to i before adding -er.)

#### DOWN

1. a machine that dries
2. a person who flies
3. a person who swims
6. a person who runs
8. a person who cuts wood
9. a person who speaks
10. a machine that receives
12. a person who drives
15. a person who votes
16. a person who sells
18. a person who rides

#### ACROSS

4. a person who wins
5. a person who rules
7. a machine that washes dishes
11. a person who reads
13. a person who employs people
14. a person who believes
17. a person who eats
19. a machine that heats
20. a person who earns
21. a person who catches

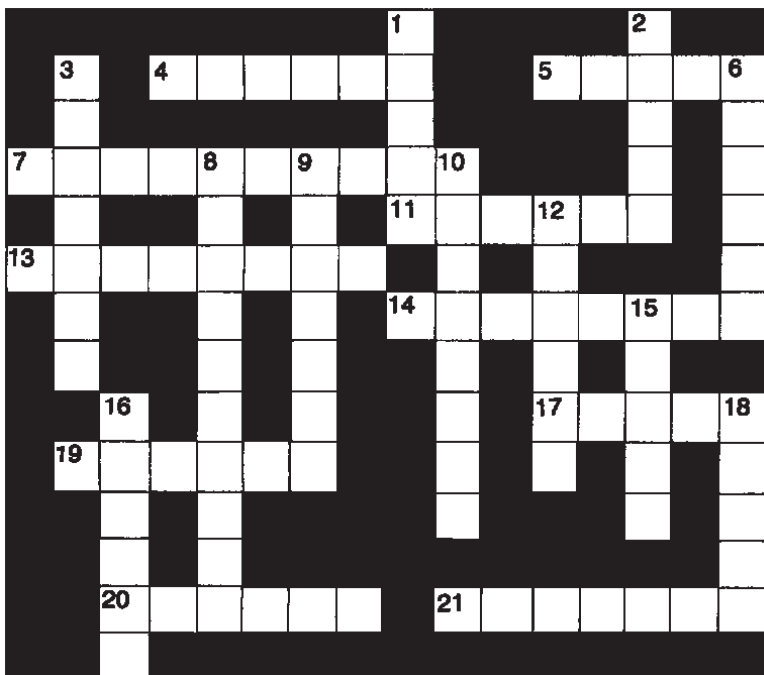



## FAMILY ROLES

Father is running after Junior. Mother is taking Sis on her bike to day care. Then she will go to work. Dad is cooking dinner. Mom is putting oil in the car and filling it with gas. And what's this? Two policemen—kissing? They are Mr. and Mrs. Thomas. They share the cooking, the housework, and a job on the police force.

Family roles are changing. In Grandmother's day, a woman was a mother, a wife, a cook, a laundress, a nurse, and a teacher. These jobs were all part of her role, but she stayed home all day. Grandmother worked only for her family. Grandfather was the money earner in the family. Little boys expected to grow up and to get jobs outside the home. Little girls looked forward to marriage and to motherhood.

Some families keep the traditional pattern: Father works and Mother stays home. In other families, there are other patterns: Mother and Father work, or Mother works and Father stays home. In a few families, two people share a job. There is more variety in lifestyles now than there was before.



## I. Mechanics

### A. Noun plurals

The plural of man is men, and the plural of woman is women. Follow the rules in chapter 3, section II and make these nouns plural: bike, car, kiss, policeman, policewoman, job, wife, laundress, nurse, pattern, person, life-style.

### B. The colon before a list of examples

The colon (:) is sometimes used to introduce a series or a list. The members of the list are separated by commas.

In Grandmother's day, a woman had many roles: wife, mother, cook, laundress, nurse, and teacher.

Copy the sentences, and make all the corrections that are necessary. Use capital letters where they are needed.

Example: in grandmother s day a woman had many roles mother wife  
cook laundress nurse and teacher  
In Grandmother's day, a woman had many roles: mother,  
wife, cook, laundress, nurse, and teacher.

1. mr and mrs thomas share many jobs the cooking the housework the shopping and a job on the police force
2. in modern families a man may help at home in many ways cleaning shopping and cooking
3. in modern families many women have two jobs one at home and one outside the home
4. in the past some jobs were always for men banking police work business medicine and law
5. a few jobs were saved for women nursing teaching and waitress work
6. now there are other patterns mother works mother and father work or mother and father share a job

## II. Grammar The past tense of to be

Study the forms for the verb to be in the past. They are irregular, so

they must be learned separately. Rewrite the paragraph below, changing all the be verbs to the past tense.

I	was	we	were
you	were		
he	}	they	were
she		was	
it			

### “I Remember Ernie”

I remember Ernie. He is a friend of mine. He’s a truck driver from the United States. I met him at a square dance. He and his wife are good dancers, and they are a lot of fun. He is generous and warm-hearted. All his friends are friendly, too. I remember the dance music. It is fast and loud. Square dancing is a good hobby.

### III. Grammar The past tense with regular verbs

Regular verbs take an -ed ending to form the past tense. The spelling rules depend on the spelling and the syllable stress of the verb.

1. Verbs that end with e simply add -d. Write the forms below with the correct spelling.

We dancedd. (dance, live, hope, move)

They smiledd. (smile, save, shave, love)

2. Verbs that end in a double consonant (VCC) or in a double vowel followed by a consonant (VCC) simply add -ed. Write the forms below with the correct spelling.

She workedd. (work, wait, count, wash, call)

He helpedd. (help, cook, watch, rush, turn)

3. Verbs that end in a single stressed vowel followed by a single consonant (VC) must add another consonant before taking -ed. Write the forms below with the correct spelling.

I plannedd. (plan, whip, brag, sob, chop)

(Notice that verbs with the stress before the last syllable do not follow this pattern. They do not take a double consonant.)

visit → visited

enter → entered

limit → limited

(A few more exceptions to the rule of the double consonant are verbs that end in w, x, or y; They do not double. Write the forms below with the correct spelling.)

You relaxeded. (relax, play, fix, saw)

4. Verbs that end in a consonant and y (Cy) change the y to i and add -ed. Write the forms below with the correct spelling.

She studieded. (study, fry, try, cry, marry, carry)

Rewrite this paragraph, changing all the verbs to past tense forms.

In most restaurants, all the cooks and waitresses work together. The head cook plans the meals. His helper shops for meat and fresh vegetables. There is one cook for the vegetables. He washes, chops, and cooks vegetables. One cook works with desserts. He whips the cream and bakes the cakes. One cook fries chicken and potatoes. The waitresses move quickly. They talk to the customers, ask for orders, pick up the food, and carry it back to the table. Everyone tries to make the restaurant a success.

#### IV. **Controlled Composition** Dicto-comp

Your teacher will read the paragraph above three times. Listen carefully, but do not take notes. After the third reading, write the paragraph as well as you can from memory. Check the spelling of all the past tense forms.

#### V. **Sentence Construction** Comparisons with more, less, and fewer

The word more can be used with plural and noncount nouns. Less is used with noncount nouns. Fewer is used with plural nouns. Study the words in the lists below.

##### Plural nouns

more	{	jobs
		people
fewer	{	problems
		customers
		cars

##### Noncount nouns

more	{	work
		variety
		traffic
less	{	food
		noise
		freedom

Use the vocabulary that is given and make a comparison between the two nouns. Add a verb and the word than.

Example: a modern woman / Grandmother / freedom  
A modern woman has more freedom than Grandmother.  
Grandmother has less freedom than a modern woman.

1. a country doctor / a city doctor / work
2. a supermarket / a corner store / variety
3. a supermarket / a corner store / jobs
4. an empty restaurant / a crowded restaurant / customers
5. a traditional culture / a modern culture / problem
6. a fat person / a thin person / food
7. the city / the country / noise
8. a busy street / a quiet street / traffic
9. a busy street / a quiet street / cars
10. a city / a town / people

#### VI. **Grammar** Sentence combining: compound sentence parts

When two sentences are very similar except for one part, they can often be combined into one longer sentence with a compound part. The most common conjunction for this kind of sentence is and.

Combine each pair of sentences below into one longer sentence. You may need to change the verb. Leave out the parts in parentheses.

Example: Father (is taking care of the children.)  
Mother is taking care of the children.  
Father and Mother are taking care of the children.

1. Grandmother was a wife.  
(Grandmother was) a cook.  
(Grandmother was) a laundress.  
(Grandmother was) a nurse.  
(Grandmother was) a teacher.
2. Little boys expected to grow up.  
(Little boys expected) to get jobs.
3. Little girls looked forward to marriage.  
(Little girls looked forward to) motherhood.

4. The roles of men (are changing.)  
(The roles of) women are changing.
5. Father (works.)  
Mother works.
6. Mother works at home.  
(Mother works) in a restaurant.
7. My parents share the cooking.  
(My parents share) the housework.
8. Mr. Thomas (works on the police force.)  
Mrs. Thomas works on the police force.
9. Mom is putting oil in the car.  
(Mom is) filling it with gas.
10. Now little boys (can look forward to a job outside the home.)  
(Now) little girls can look forward to a job outside the home.

## VII. **Controlled Composition** Variety in sentence types

Good writers use some short, simple sentences and some longer sentences. Rewrite the paragraph below and vary the length of the sentences. Make some longer, and change the word order in some. Combine some sentences with and, but, or, and so.

My name is June Taylor. My daughter Sara lives in Fairbanks, Alaska. I live in Fairbanks, Alaska. I am a working mother. I work as a camera-woman for a T.V. station in Fairbanks. My job is interesting. I enjoy it. I didn't always work. I didn't plan to work. I started to work ten years ago. This is my story.

I married Charles Taylor in 1966. We were very young. Charles was a salesman. He liked to move. We moved to a new city every year. We lived in Chicago. We lived in Detroit. We lived in Miami. We lived far from our families. Charles wanted a large family. I wanted a large family. I didn't plan to get a job. I planned to stay home with the children.

Sara was born in Miami. Charles was very happy. I was very happy. I stayed home with Sara. We moved to Alaska the next year. I didn't have a job. I had a hobby. I liked to take pictures of Sara. I learned to take very good pictures. I started to sell them. It wasn't a real job. I always worked at home.

Charles suddenly became very sick in 1972. He had cancer. He died after six months. I had no money. I had no job. I had no education. I had

no friends. Then a T.V. station in Fairbanks saw my pictures. They asked me to work for them. I am very lucky to have the job. I can earn enough money for Sara and me. We are independent. I don't worry about the future any more.

### VIII. **Controlled Composition** Choosing relevant information

Choose sentences from the list below and write two separate paragraphs. Choose relevant information and organize the sentences into a clear order. The topics are: "Working Women—a Bad Idea" and "Working Women—a Good Idea." Each paragraph will have eight sentences.

1. It is bad for women to work outside the home.
2. Working women have too much freedom.
3. It is healthy for women to work outside the home.
4. Working women are interesting people.
5. They have new ideas to share with their family.
6. The extra money makes life better.
7. They forget the needs of their family.
8. The house becomes dirty, and dinner is always late.
9. All the people in the family help each other.
10. Children and husbands learn to do housework.
11. Working women don't need their husbands any more.
12. They love their jobs more than they love their husbands.
13. If the husband is sick or out of work, the wife can earn money for the family.
14. Families are safer when women work.
15. It is better for women to stay at home.

# TALL TALES

## “Old Stormalong”

Old Stormalong was the greatest and the biggest sailor of all. He was a large baby, and then he grew even bigger. He was as big as the ships of New England. He drank his soup out of a whaling boat. He slept on the deck of the ship, because there was not enough room below deck for him.

“They don’t make ships big enough for me,” said Stormalong.

Old Stormalong went to sea with Captain Starbuck on a whaling ship, the *Nancy Ann*. They sailed to the middle of the ocean and looked for whales.

“There she blows! A whale! And another!” called the lookout.

“It’s a whole school of whales!” called the second lookout.

“Into the boats!” cried Captain Starbuck.

Stormalong jumped from the ship into a whaling boat, but the whaling boat wasn’t big enough for him. He was so big that he made a hole in the bottom of the boat. The water ran in, and the sailors fell out.

“You big elephant!” cried Captain Starbuck. “I’m sorry I ever saw you.”

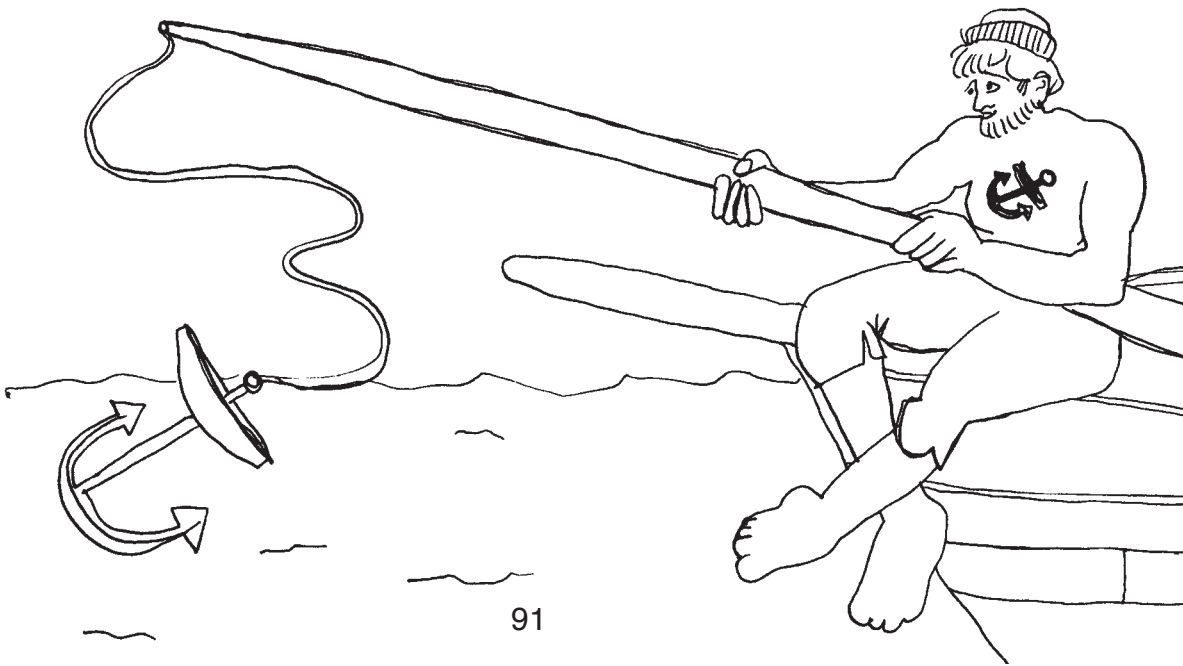



Old Stormalong became very angry. He did a wonderful thing. He swam back to the ship and took down a mast. Then he cut rope for a line. Next he put an anchor on for a hook. He made the biggest fishing pole in the world. Finally he put a piece of salt pork on the anchor.

“I will catch that whale like a fish,” he said.

Stormalong threw the line to a whale. The anchor flew through the air and hit the water by the whale. The whale bit the anchor and swam away. It pulled the *Nancy Ann* all over the ocean, up and down, to Cape Cod.

Captain Starbuck thought he had the biggest whale in the world. “It was a lucky day when I met you, Stormalong,” said the captain.

Then the Cape Cod sea monster came up from the deep sea. The monster bit the whale and ate it all. It ate the anchor, too, and sank down into the sea.

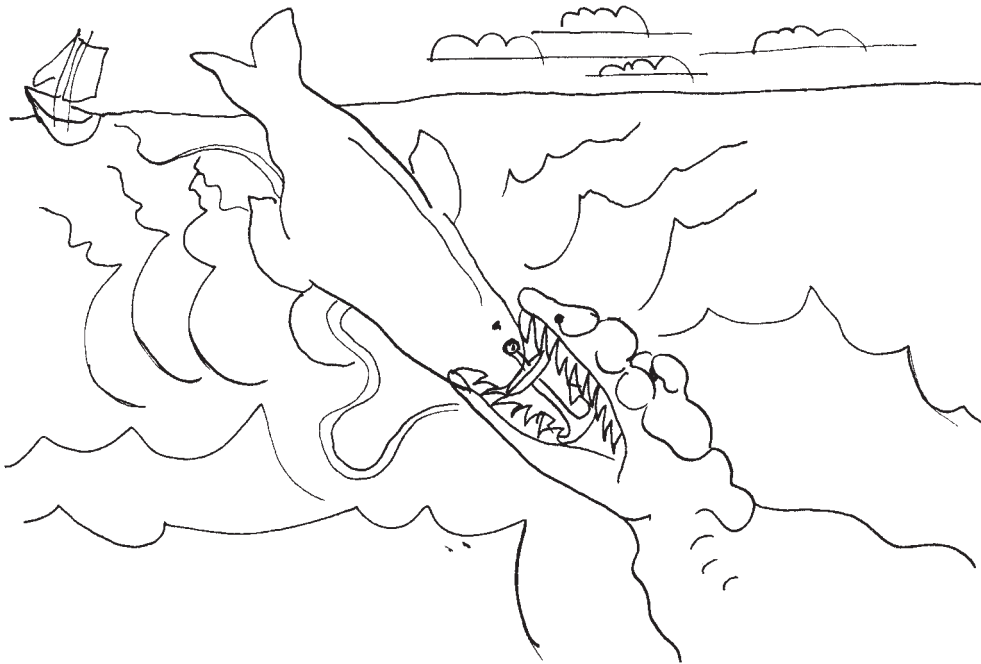

“You big elephant!” cried Captain Starbuck again to Stormalong. “You lost my whale.”

“I tried sailing, and I tried whaling,” said Stormalong. “The ships are too small, and a man gets tired. I am going to be a farmer, and you can bet on that.” He jumped off the ship and walked through the water to shore.

## I. Mechanics

### A. Review of comparisons

Follow the rules in chapter 13, section II and write the comparative and superlative forms of these words: great, large, lucky, strong, wonderful, fast, hard, angry, dangerous, small, wild, high, low, deep, dry

### B. Quotation marks (“ ”)

When you tell a story, you may sometimes tell the exact words that a person said. Put quotation marks around these words:

“The ships are too small,” said Stormalong.

Do not put quotation marks around the names of the people who are talking.

Copy the sentences, and make all the corrections that are necessary. Use capital letters when they are needed, and use quotation marks.

1. they don t make ships big enough for me said Stormalong
2. there she blows a whale and another called the lookout
3. it s a whole school of whales called the second lookout
4. into the boats cried captain starbuck
5. you big elephant cried captain starbuck i m sorry i ever saw you
6. i will catch that whale like a fish he said
7. it was a lucky day when i met you Stormalong said the captain
8. you big elephant cried captain starbuck again you lost my whale
9. i tried sailing and i tried whaling said Stormalong
10. the ships are too small and a man gets tired i am going to be a farmer and you can bet on that

## II. Grammar Past tense irregular verbs

Look at the text and find the past tense form for each of these verbs. Write the simple form with its past tense.

is	say	fall	swim	take	think	sink
grow	go	see	fly	cut	meet	lose
drink	make	become	hit	put	come	
sleep	run	do	bite	throw	eat	

The paragraph below tells about heroes and tall tales. Rewrite the paragraph, changing all the verbs from present to past. Change heroes to Stormalong, and change they to he.

#### “Heroes and Tall Tales”

Heroes are larger than life. They grow very big, and they become very strong. They do wonderful things. They drink more and eat more than other people do. They swim better, run faster, throw farther, and hit harder. They don't say much, but they do a lot. They are very independent, too. Of course, the stories about heroes aren't really true. Tall tales about heroes are just stories that people tell for fun.

### III. **Controlled Composition** Dicto-comp

Your teacher will read the paragraph about Stormalong (in the past tense, above) three times. Listen carefully, but do not take notes. After the third reading, write the paragraph as well as you can from memory. Check the spelling of all the past tense forms.

### IV. **Sentence Construction** Questions and negatives with did

The helping verb for the past tense is did. It is used with questions and negatives. Study these examples:

How did Stormalong drink soup?

Did Stormalong drink soup out of a whaling boat?

He didn't have a bowl large enough.

Use the vocabulary that is given and write a question or an answer for each group. You will need to add the helping verb did.

1. where / Stormalong / sleep / ?  
Stormalong / sleep / on deck / ?  
he / (not) have / a bed large enough / .
2. where / Stormalong / go / ?  
Stormalong / go / to sea / ?  
he / (not) stay / on land / .
3. where / the ship / sail / ?  
the ship / sail / to the middle of the ocean / ?  
they / (not) stay / on shore / .

4. what / they / look for / ?  
they / look for / whales / ?  
they / (not) look for / elephants /.
5. what / the lookout / see / ?  
the lookout / see / a school of whales / ?  
he / (not) see / a school of children /.
6. what / Stormalong / do / ?  
Stormalong / make / a hole in the whaling boat / ?  
they / (not) have / a boat large enough /.
7. how / Stormalong / feel / ?  
Stormalong / become angry / ?  
he / (not) like / to lose whales /.
8. why / Stormalong / take a mast / ?  
why / Stormalong / make a fishing pole / ?  
he / (not) have / a whaling boat large enough /.

V. **Grammar** Using very, too, enough, so...that, and such...that

In American tall tales, the heroes often brag. They tell stories about their size or the wonderful things they can do. Here are some examples.

Davy Crockett was very strong.

He was so strong that he burned up a tree by smiling at it.

He was tall enough to hang his gun up on the moon at night.

He was so fast that he rode on lightning.

No bear was too big for Davy.

He was such a strong man that he hugged a bear to death.

Students often confuse the meanings of these words.

Very means a large degree, a large amount, or a large number.

Too means so much that there is a bad result.

Enough means sufficient, so that there is a good result.

So (+ an adjective) that describes a result.

Such a (+ a noun) that describes a result.

Copy the sentences below, and fill the blanks with one of these words.

1. Stormalong was \_\_\_\_\_ big. (a large degree)
2. Stormalong was \_\_\_\_\_ big for the ship. (a bad result)
3. The ship was \_\_\_\_\_ small for Stormalong. (a bad result)

4. "They don't make ships big \_\_\_\_\_ for me," said Stormalong.  
(sufficiently big)
5. He was \_\_\_\_\_ big \_\_\_\_\_ he drank his soup out of a whaling boat.  
(result)
6. He was \_\_\_\_\_ \_\_\_\_\_ large man \_\_\_\_\_ he couldn't go below  
deck. (result)
7. There were \_\_\_\_\_ many whales. (a large number)
8. Stormalong jumped \_\_\_\_\_ hard. (a bad result)
9. The boat wasn't big \_\_\_\_\_ for him. (sufficiently big)
10. He was \_\_\_\_\_ big \_\_\_\_\_ he made a hole in the boat. (result)
11. It was \_\_\_\_\_ \_\_\_\_\_ large hole \_\_\_\_\_ all the sailors fell out.  
(result)
12. Stormalong became \_\_\_\_\_ angry. (a large degree)
13. A regular fishing pole was \_\_\_\_\_ small for him. (a bad result)
14. A mast from the ship was large \_\_\_\_\_ for him. (sufficiently large)
15. He made a \_\_\_\_\_ long fishing pole. (a large degree)
16. It was \_\_\_\_\_ large \_\_\_\_\_ he caught a whale with it. (result)
17. The whale was \_\_\_\_\_ strong. (a large degree)
18. It was \_\_\_\_\_ \_\_\_\_\_ strong whale \_\_\_\_\_ it pulled the ship through  
the ocean. (result)
19. The whale wasn't fast \_\_\_\_\_ to run from the monster (sufficiently  
fast)
20. Stormalong was \_\_\_\_\_ angry \_\_\_\_\_ he left whaling and sailing  
to be a farmer. (result)

## VI. **Controlled Composition** Organizing ideas

The sentences below tell the story of another American folk hero, Davy Crockett. Davy was a very strong hunter. People say that he killed animals like bears with his bare hands. The sentences in the story are out of order. Notice words like next, then, after, and afterwards. Copy the story, putting the sentences and paragraphs into a logical order.

### Paragraph 1

Davy Crockett was born in the woods of Tennessee.

He wanted to go hunting again at the age of five.

Davy did the housework, but he hated it.

He wanted to go hunting at the age of three.

But his mother said, "You're too young for hunting, Davy."

This time his mother said, "You can hunt after you do the housework."

### Paragraph 2

He met a wild animal called a panther.

Davy wasn't afraid of the panther, either.

The panther wasn't afraid of Davy.

He said to the panther, "I can fight harder, shoot farther, run faster, jump higher, squat lower, dive deeper and come up drier than any man in these parts!"

After the housework, Davy went out in the woods to hunt.

### Paragraph 3

The panther jumped at Davy.

Then Davy jumped at the panther.

Davy never did housework again.

They fought for two hours, and Davy won.

Next he taught the panther to do housework.

Afterwards he brought the panther home.

(Adapted from Irwin Shapiro, "Davy Crockett,"  
*Tall Tales of America*, Artists and Writers Press,  
Western Printing and Lithography Co., 1958.)

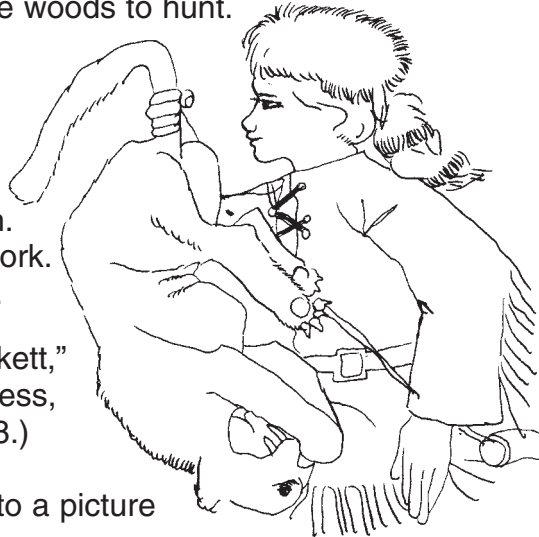

## VII. **Controlled Composition** Responding to a picture

Sometimes people really do things that are exciting and difficult. Look at the picture below. The boy was so lucky that he caught a fish with his bare hands. Write a story and tell what happened. Use past tense verbs and include some quotes. Tell what the boy and his friends said, and how they felt.



### VIII. **Controlled Composition** Responding to a picture

What happened to the man in the picture below? Did he kill the leopard? Did he have a gun, or not? Did he use his bare hands? Use your imagination and write a story to go with the picture. Use past tense verbs.



## MAKING A BANANA SPLIT



Here is the recipe for a popular American dessert. It's called a banana split.

bananas  
ice cream

sauce  
cherries

cream  
nuts

First, take one whole banana. Peel the banana and cut it in half lengthwise. Put the banana in the bottom of a long dessert dish. Set the dessert dish aside.

Next, take out three different kinds of sauce. The most popular kinds of sauce are chocolate, caramel, and pineapple. Heat the chocolate sauce until it boils. While the chocolate sauce is heating, take out three different kinds of ice cream from the freezer. The most popular kinds of ice cream are vanilla, strawberry, and chocolate. Use an ice cream scoop to make round balls of ice cream. Put the balls of vanilla, chocolate, and strawberry ice cream on each banana.

Pour the caramel sauce on the chocolate ice cream. Pour the pineapple sauce on the strawberry ice cream. When the chocolate sauce is hot, pour it on the vanilla ice cream.

Next, whip some cream until it is stiff. Chop some nuts. When the cream is stiff, put some whipped cream on the ice cream. Put chopped nuts over everything. Finally, put a cherry on top.

Enjoy your banana split!



## I. Mechanics

### A. Regular and irregular past tense verbs

Follow the rules in chapter 14, section III and write these verbs in the past tense: start, peel, heat, chop, whip, scoop, pour, cover, top. Use the list of irregular verbs in the appendix in the back of the book to write these verbs in the past tense: have, take, cut, put, set

### B. Using a comma after a subordinate clause

A clause that begins with a subordinate conjunction (such as before, after, when, while, until) is called a subordinate clause. If the subordinate clause comes first in a sentence, you must separate it from the main clause with a comma. Study these examples:

Before you eat a banana, peel the skin off.  
subordinate clause (comma) main clause

Peel the skin off before you eat a banana.  
main clause (no comma) subordinate clause

Copy the sentences, and make all the corrections that are necessary. Use commas, and use capital letters when they are needed.

1. before you begin have everything ready
2. peel the banana before you cut it
3. after you cut the banana put it in a dish
4. heat the chocolate sauce until it boils
5. while it s heating take out the ice cream
6. when you scoop out the ice cream make little round balls
7. put the ice cream on the banana before you pour the sauce
8. when the chocolate sauce is hot pour it over the ice cream
9. whip some cream until it is stiff
10. chop some nuts while your friend is whipping the cream
11. when the cream is stiff put it on the ice cream
12. after you put on the cream add nuts and a cherry

## II. Grammar The past progressive tense

The past progressive tense is a combination of two verbs. The auxiliary is a form of to be, in the past, and the main verb takes an -ing ending.

We were eating ice cream.

Change the sentences below from present progressive to past progressive.

1. Lavonne, Shirley, and Linda are making banana splits.
2. Lavonne is peeling bananas and cutting them in half.
3. Shirley is scooping out ice cream balls.
4. Linda is heating the sauce.
5. While the sauce is heating, she is also chopping nuts.
6. Lavonne is whipping cream until it is stiff
7. Shirley is pouring the sauce over the ice cream.
8. Lavonne is putting whipped cream on the ice cream.
9. Linda is putting nuts and cherries on the desserts.
10. The women are serving customers in an ice cream shop.

## III. Controlled Composition Past narration

The recipe for a banana split used many simple verb forms, and the subject (you) was usually not given. Recipes and other directions are written that way. To write a report of something that happened in the past, you need to add a subject to every clause, and use past tense verbs.

Change the paragraph below from imperative to narrative style.

1. Add a subject — I — and use past tense verbs.
2. Simple verbs change to past tense.
3. Present progressive changes to past progressive.

Have everything ready before you start. First take one whole banana. Peel it and cut it in half lengthwise. Put the banana in the bottom of a long dessert dish and set it aside.

Heat some chocolate sauce. While the sauce is heating, chop some nuts. Whip some cream until it is stiff. Scoop out ice cream and put balls of ice cream on the banana. When the sauce is hot, pour it over the ice

cream. Cover the ice cream with whipped cream and chopped nuts. Top everything with a cherry.

#### IV. Grammar Sentence combining with adverb clauses

Use the subordinate conjunctions before, after, until, when, and while to combine the clauses below. (While is used with a progressive tense.) Write each sentence in two ways: with the main clause first; then with the subordinate clause first.

Example: Shirley took all the food out. }  
 The women began to cook. } before  
 Shirley took all the food out before the women began to cook.  
 Before the women began to cook, Shirley took all the food out.

1. Lavonne cut the bananas in half. }  
 She peeled them. } after
2. Linda was heating the sauce. }  
 Shirley was scooping out ice cream. } while
3. The sauce was heating. }  
 Linda was chopping nuts. } while (Write one sentence only, main clause first)
4. Lavonne whipped the cream. }  
 It was stiff. } until
5. The sauce (it) was hot. }  
 Shirley poured the sauce (it) over the ice cream. } when (Use a pronoun in the second clause.)
6. Shirley poured the sauce. }  
 Lavonne put on the whipped cream. } before
7. Linda (she) put on nuts. }  
 Linda (she) put on cherries. } after (Use a pronoun in the second clause)

#### V. Grammar Review of articles, some as a quantifier

Remember that noncount and plural nouns do not take an article when the meaning is general, or when they are mentioned for the first time. In many cases, however, the word some is used to give the idea of

an indefinite number or quantity. The second time the noun is mentioned, use the definite article the.

Copy the paragraph and write articles in the spaces where they are needed.

### “Baked Alaska”

Take out \_\_\_\_\_ large bowl, \_\_\_\_\_ smaller bowl, \_\_\_\_\_ electric beater, \_\_\_\_\_ large plate, and \_\_\_\_\_ wooden spoons. Have ready \_\_\_\_\_ flat cake, five egg whites, \_\_\_\_\_ sugar, and \_\_\_\_\_ liter of ice cream. You need \_\_\_\_\_ freezer and \_\_\_\_\_ oven.

Place \_\_\_\_\_ cake on \_\_\_\_\_ plate. Put \_\_\_\_\_ ice cream in \_\_\_\_\_ large bowl. Beat it with \_\_\_\_\_ electric beater until it is a little soft. Pile \_\_\_\_\_ ice cream on \_\_\_\_\_ cake in \_\_\_\_\_ pretty shape. Then put \_\_\_\_\_ ice cream and cake back into \_\_\_\_\_ freezer. Freeze \_\_\_\_\_ ice cream until it is solid.

While \_\_\_\_\_ ice cream is freezing, put \_\_\_\_\_ egg whites in \_\_\_\_\_ smaller bowl. Beat \_\_\_\_\_ egg whites until they are stiff. While you are beating, slowly add two-thirds \_\_\_\_\_ cup of sugar. Beat until \_\_\_\_\_ sugar is dissolved and \_\_\_\_\_ egg whites are very stiff. Turn \_\_\_\_\_ oven on very hot.

Take \_\_\_\_\_ cake out of \_\_\_\_\_ freezer. Spread \_\_\_\_\_ egg whites over \_\_\_\_\_ ice cream. Cover all \_\_\_\_\_ ice cream carefully. Put \_\_\_\_\_ cake into \_\_\_\_\_ oven and bake it for three minutes, until \_\_\_\_\_ egg whites are golden brown. Remove \_\_\_\_\_ dessert and serve it immediately with \_\_\_\_\_ chocolate sauce. \_\_\_\_\_ ice cream is still frozen, but \_\_\_\_\_ egg whites are hot. \_\_\_\_\_ cold ice cream gives this dessert its name, “Baked Alaska.”

## VI. **Controlled Composition** Dicto-comp

Your teacher will choose one of the exercises from this chapter and read it as a dicto-comp, either exercise III (past narration), or exercise V (review of articles.) Listen carefully, but do not take notes. After the third reading, write the paragraph as well as you can from memory. Check for articles and tenses.

## VII. **Controlled Composition** Organizing ideas

The sentences below give directions for making another kind of food,

the “submarine sandwich.” The directions are out of order. Notice words like first, next, then, before, after, when, finally. Copy the recipe, putting the sentences into a logical order.

Next, scoop out some of the inside of the bread to make room for the filling.

First, cut the bread in half lengthwise.

Take a long loaf of French bread, some butter, some lettuce, some onions, some tomatoes, some meat, and some cheese.

Then butter the bread.

After the onions, put on the tomatoes.

Put the onions on after the lettuce.

Put the cheese on after the meat.

When the bread is buttered, start to pile on the filling.

The lettuce comes first.

Finally, cover the filling with the top piece of bread.

When the filling is in the sandwich, pour some sauce over everything.



### VIII. **Controlled Composition** Past narration

Rewrite the recipes for Baked Alaska (Exercise V) and the submarine sandwich (Exercise VII) as past narration. Add a subject to every clause, and use past tense verbs. Follow the rules in Chapter 14, Section III for the past tense of regular verbs. Use the list in the back of the book to find irregular verb forms.

### IX. **Free Composition**

Write directions for a recipe that you know. Explain to somebody how to make that kind of food.

## A DEBATE: DOGS IN THE CITY

### Letters to the Editor

#### **Man's Best Friend Not Welcome in City Life**

Dear Editor,

What is wrong with the owners of dogs in this city? Every time I go out for a walk, I have to compete with big dogs for a place to walk! Dogs are loud and dirty; moreover, they frighten little children and old ladies. The city is no place for a dog. Big dogs need a lot of room for running;

therefore, they should live in the country....Can't the city pass a law against dogs?

Fred Brown, head pharmacist  
Westside Pharmacy, Centerville



Local pet with  
owner taking a walk

### **...Or is he?—Two views**

Dear Editor,

Many people are speaking out against large dogs these days. This is not fair because dogs can't speak for themselves. They are man's best friend; therefore, I will speak for dogs.

The city already has a leash law; owners must keep their dogs tied up on a leash. The city also has health laws; owners must clean up after their dogs. There is no law against owning a dog, unless the dog hurts somebody.

People should have big dogs if they want them. City life can be sad and lonely for older people; however, dogs are good friends. Moreover, dogs make life safer. Even though they are animals, they can show

loyalty and intelligence. We train our dogs to be gentle; as a result, they are very patient and good with children. Our dogs sit outside our store all day and don't make any trouble.

Of course, dog owners should be thoughtful. They must not let their dogs run loose; in addition, they must keep the streets clean. These things are important; however, we already have leash laws and health laws. We don't need any more laws about dogs; besides, the city can't pass a law against dogs anyway. Everyone is free to own a dog.

Thank you for printing my letter.

Bob Kovacik, owner  
Bob and Marsha's Grocery

## I. Mechanics

### A. Review of comparisons

Follow the rules in chapter 13, section II and write the comparative and superlative forms of these words: loud, dirty, sad, lonely, thoughtful, clean, important, expensive, friendly, intelligent, pretty, patient, loyal, independent, nice

### B. The semi-colon (;) in sentence combining

There are two ways that a semi-colon can be used to combine sentences.

1. If two sentences are very close in meaning, or if they have a cause-effect relationship, they may be joined with a semi-colon.

Example: The city already has a leash law; owners must keep their dogs tied up on a leash. (The two sentences are very close in meaning.) Mr. Kovacik trained his dogs well; they don't make any trouble. (The two sentences have a cause-effect relationship.)

2. Conjunctive adverbs are used with semi-colons to join sentences. Use a semi-colon before the adverb and a comma after the adverb. Some conjunctive adverbs are: therefore, as a result, however, nevertheless, on the other hand, besides, moreover, in addition.

Copy the sentences, and make the corrections that are necessary. Use semi-colons, and use capital letters where they are needed.

1. some people love dogs other people hate them
2. mr brown wants a law against dogs he says dogs are a problem in the city
3. dogs are loud and dirty moreover they always run loose
4. dogs need room for running therefore they should not live in town
5. dogs can t speak for themselves therefore i will speak for them
6. a dog is more than a pet a dog is a friend
7. dogs are animals nevertheless they are intelligent
8. we train our dogs as a result they can do tricks
9. dog owners should be thoughtful they must not let their dogs run loose
10. the city already has health laws owners must clean up after their dogs
11. mr brown is right about these problems on the other hand the city can t pass a law against dogs
12. policemen use dogs in their work in addition blind people need dogs

## II. Grammar Sentence combining with subordinate conjunctions and conjunctive adverbs

Combine each pair of sentences into one longer sentence. Remember that the punctuation pattern is different for subordinate conjunctions and conjunctive adverbs.

<u>Conjunctions</u>	<u>Adverbs</u>
because (introduces a cause)	therefore
	as a result
	} introduce a result
if (introduces a condition)	
unless (means <u>if not</u> )	however
	nevertheless
	on the other
	hand
	} (introduce an idea that disagrees with the first idea)
even though	
although	
} (introduce an idea that disagrees with the first idea)	
	besides
	moreover
	in addition
	} (introduce an idea that agrees or gives more reasons)



1. Mr. Brown (he) doesn't like dogs (them).  
Mr. Brown (he) thinks dogs (they) are dirty, (because)  
Mr. Brown doesn't like dogs because he thinks they are dirty.  
Because Mr. Brown thinks that dogs are dirty, he doesn't like them.  
(Two patterns are possible; either the main clause or the subordinate clause may come first. Use pronouns in the second clause.)
2. Mr. Brown thinks dogs are dirty. He doesn't like them. (therefore)  
Mr. Brown thinks dogs are dirty; therefore, he doesn't like them.  
(This is the only pattern that is possible.)
3. Old people (they) are lonely. Old people (they) have a dog.  
(unless)
4. Old people (they) won't be lonely.  
Old people (they) have a dog. (if)
5. Dogs are only animals. They are loyal and intelligent.  
(although)
6. Dogs are only animals. They are loyal and intelligent.  
(however)
7. We already have good laws about dogs.  
Some people don't follow the laws (them), (even though)
8. We already have good laws about dogs.  
Some people don't follow them. (nevertheless)
9. There is a leash law. There is a health law.  
(in addition)
10. The city can't pass a law against dogs.  
Nobody would follow it. (besides)

### III. Sentence Construction Concentration

This is a game you can play with another person. Cut squares of paper to fit over each box below. Cover each box with a square of paper. Have a pencil and paper ready to write sentences.

The first player turns over two squares. He reads the words in the boxes. If they make a good sentence, he writes the sentence on his paper. He leaves the boxes uncovered. If the clauses do not go together to make a long sentence, he covers them again. (Remember what is under each square of paper!) The second player takes his turn. Continue playing until all the squares are covered.

The player with the most sentences on his paper is the winner.

Dogs are “man’s best friend;”	they won’t cause trouble.	Dogs are dirty;	Dogs are patient;
If you train your dogs well,	however, Mr. Brown hates dogs.	they may cause trouble.	Mr. Brown hates dogs.
therefore, they are happier there.	Unless you train your dogs well,	Dogs can run loose in the country;	because they can run loose there.
Dogs are happier in the country.	moreover, dogs are loved.	Although dogs are “man’s best friend.”	in addition, they are loyal.

#### IV. Grammar Modal auxiliaries

The letters to the editor in this chapter have some auxiliary verbs called “modals.” They help to express your ideas, opinions, and feelings: can, can’t, have to, don’t have to, must, must not, should, should not.

Study the meanings of these verbs. Copy the paragraph below and write a modal verb in each blank.

can ability

can’t lack of ability

have to necessity (the same as must)

don’t have to freedom of choice, no obligation or necessity)

must necessity (the same as have to)

must not necessity not to do something, prohibition

should, obligation, “a good idea”

should not obligation not to do something, not “a good idea”

The city can pass a health law, and the city \_\_\_\_\_ pass a leash law; however, it \_\_\_\_\_ pass a law against owning dogs. The law says that dog owners \_\_\_\_\_ tie up their dogs; they \_\_\_\_\_ let the dogs run loose.

The city \_\_\_\_\_ take a dog from its owner unless the dog hurts somebody. Dog owners \_\_\_\_\_ follow these laws, or they \_\_\_\_\_ pay money for breaking the laws. In addition, dog owners \_\_\_\_\_ try to be thoughtful. They \_\_\_\_\_ think about their neighbors, and they \_\_\_\_\_ do anything to make their neighbors angry. The city \_\_\_\_\_ pass a law to make people thoughtful, but we \_\_\_\_\_ all try to think of our neighbors.

**V. Controlled Composition** Dicto-comp

Your teacher will read the paragraph above three times. Listen carefully, but do not take notes. After the third reading, write the paragraph as well as you can from memory. Check your punctuation and sentence combining techniques.

**VI. Controlled Composition** Variety in sentence types

Good writers use some short, simple sentences and some longer sentences. Rewrite the paragraph below and vary the length of the sentences. You may make some longer by combining them with coordinate conjunctions, subordinate conjunctions, or conjunctive adverbs. Here is a list of the connectors we have used so far:

<u>Coordinate Conjunctions</u>	<u>Subordinate Conjunctions</u>	<u>Conjunctive Adverbs</u>
and	after	so...that
but	although	such...that
or	because	unless
so	before	until
	even though	when
	if	while
		as a result
		besides
		however
		in addition
		moreover
		nevertheless
		on the other hand
		therefore

“Cats and Dogs”

Some people like cats. Other people like dogs. People have strong ideas about cats. People have strong ideas about dogs. People often don't have both cats and dogs in the same house.

Cat owners talk about their pets with love. Cats are quiet. Cats are clean. Cats are good in apartments. They don't need a lot of space. They

don't run around a lot. The apartment has mice. Cats catch them. Cats are independent. They can stay home alone. The owners go to work. Cats are pretty animals. They are fun to watch.

Dog owners think dogs are nice. They don't want any other animal. Dogs are friendly. Dogs are loyal. Dogs are patient. Dogs are good with children. They can learn to behave correctly. They can learn to stay out of your food. Cats can't learn to stay out of your food. Dogs protect the family. Dogs protect the house. Dogs show their love. Cats don't show their love.

## VII. **Controlled Composition** Incomplete dialog

Police officer Frank Thomas received a complaint about a loud dog in the neighborhood. He rode his motorcycle to the address, at the corner of Midway Avenue and River Drive. Now he is asking questions.

Below are the answers that he is getting. Write a good question before each answer. When you finish you will have a dialog that you can act out with a partner.

Officer Thomas: Who called in about the dog?

Fred Brown: I did, Officer. I called in about the dog.

Officer Thomas: \_\_\_\_\_?

Fred Brown: Because the dog is barking. It's Sunday. I'm trying to sleep. Listen to that noise!

Officer Thomas: \_\_\_\_\_?

Fred Brown: It started an hour ago. How can anybody sleep with that noise?

Officer Thomas: I'll ask the questions, Mr. Brown. You just give the answers.

Fred Brown: Yes, sir.

Officer Thomas: \_\_\_\_\_?

Fred Brown: My neighbor owns him.

Officer Thomas: \_\_\_\_\_?

Fred Brown: His name is Kovacik. Bob Kovacik. They own the grocery store on the corner.

Officer Thomas: \_\_\_\_\_?

Fred Brown: They bought the dog last year. After a robbery. They think it will keep the robbers away.

Officer Thomas: \_\_\_\_\_?

Fred Brown: No, it doesn't. It doesn't bark a lot. This is the first time.

Officer Thomas: \_\_\_\_\_?

Fred Brown: No, I didn't call Mr. Kovacik. I called you first. I can't talk to him. How can you talk to a dog owner?

Officer Thomas: That's a question, Mr. Brown. I'll ask the questions.

Fred Brown: Sorry.

Officer Thomas: \_\_\_\_\_?

Fred Brown: Where? Oh, there. No, that's not Mr. Kovacik. I don't know that man. He is running very fast, isn't he?

Officer Thomas: Stop in the name of the law!

\_\_\_\_\_?

The strange man: I wasn't doing anything. I was just in the store.

Officer Thomas: \_\_\_\_\_?

The strange man: Because I wanted to buy some food.

Officer Thomas: On Sunday? Today is Sunday. That store's not open. \_\_\_\_\_?

The strange man: What bag? Oh, this bag? Oh, there's nothing in this bag. Oh, how did that money get in that bag?

Officer Thomas: I'll ask the questions.

The strange man: O.K., Officer. You win. I took that money from the grocery store an hour ago, but that big dog didn't let me go until now.

### VIII. Free Composition

A. Write a paragraph about a pet. It can be a cat, a dog, a bird, or any other animal. Tell why you like this animal.

Here are some vocabulary words that may help you:

friendly

intelligent

pretty

patient

good with children

loyal

quiet

clean

independent

fun

nice

catch mice

protect the family

learn tricks

show love

B. Write a paragraph about an animal that you don't like. Give reasons. Here are some vocabulary words that might help you:

loud  
dirty  
dangerous  
expensive  
run loose

frighten people  
bite  
bark (for dogs only)  
hurt people  
make trouble



## PLANNING A TRIP

1239 Lincoln Boulevard  
Fairbanks, Alaska 99701  
U.S.A.  
May 14, 1983

Dear Roberto,

There are only two weeks now before my trip begins. I'm very excited. I can hardly wait to see you.

My uncle has sent me my plane tickets, and I have received them already. I have written letters to both grandmothers, so they know when I'm coming. I haven't seen Grandmother Taylor in Chicago for two years. I haven't seen Grandmother Singer in Miami since I was ten.

I'll stay in Chicago for a week, and I'll be in Miami for another week. My plane will land in Caracas on June 14, just one month from today. I'll stay with my uncle for a month, until July 15.

What clothes will I need in Venezuela? I haven't bought anything new yet. I've never visited outside the United States before. I've never flown alone before, either. I won't be afraid. My uncle will pick me up at the airport in Caracas. My mom says I won't have any trouble. I hope not. (Just think—I'll be a "world traveller" when this trip is over.)

See you in Caracas.

Yours,  
Sara

## I. **Mechanics** Contractions with have and will

The helping verb for the present perfect tense is have. The helping verb for the future is will. These auxiliaries can combine with the subject pronouns and with not to form the contractions below. These contractions are common in informal writing and in speech.

---

I	+	have	=	I've	we	+	have	=	we've
you	+	have	=	you've					
she	+	has	=	she's	he	+	has	=	he's
it	+	has	=	it's	they	+	have	=	they've
have	+	not	=	haven't	has	+	not	=	hasn't

---

I	+	will	=	I'll	we	+	will	=	we'll
you	+	will	=	you'll					
he	+	will	=	he'll	they	+	will	=	they'll
she	+	will	=	she'll					
it	+	will	=	it'll	will	+	not	=	won't

---

Copy the sentences below, and make all the changes that are necessary. Use an apostrophe (') in each contraction.

1. sara won t leave fairbanks until June 1
2. she won t be in Caracas until June 14
3. she ll visit her grandmothers in Chicago and miami
4. they ll be happy to see sara
5. they haven t seen sara for years
6. she ll fly to Caracas on June 14
7. sara s uncle lives in Caracas
8. he ll pick her up at the airport
9. he s sent her the tickets and she s received them
10. they ve made all their plans already
11. sara hasn t flown alone before
12. she won t have any trouble

## II. **Sentence Construction** The present perfect tense

The present perfect tense is a combination of two verbs. The auxiliary is a form of have (have or has), and the main verb takes a participle form.



1. Most verbs take -ed to form a participle. The spelling rules for the -ed ending are the same as the rules for the past tense. Follow the spelling rules for the past tense forms and write the participles for the verbs below.

hope	receive
land	visit
need	stay
pick up	wait

2. The participles for irregular verbs are different, and must be learned separately. Here are the past and participle forms for the verbs in Sara's letter. (A more complete list of irregular verbs is in the back of the book.)

<u>Simple Form</u>	<u>Past Tense</u>	<u>Participle Form</u>
be	was, were	been
begin	began	begun
buy	bought	bought
fly	flew	flown
have	had	had
know	knew	known
say	said	said
see	saw	seen
send	sent	sent
think	thought	thought
write	wrote	written

Make a sentence for each group of words below. Use the present perfect tense, and use have or has with a participle form.

1. Sara / receive / her tickets / already
2. Her trip / (not) begin / yet
3. She / (not) buy / any new clothes / yet
4. Sara / send / a letter / to her grandmothers
5. She / write / to Roberta
6. She / (not) fly / to Caracas / before
7. Sara's father / be / dead / for ten years
8. Her uncle / live / in Caracas / for one year
9. Sara / (not) visit / her uncle / in Caracas before
10. Sara / (not) see / Roberta or his family / before

### III. **Controlled Composition** Incomplete dialog

It's the day before Sara's trip. Her mother is helping her get ready. Mrs. Taylor is asking Sara what she has done. Sara's answers are given below. Write a good question before each answer. When you finish, you will have a dialog that you can act out with a partner.

"What Have You Done So Far?"

Mrs. Taylor: What have you done so far, Sara? Have you written to Grandmother Taylor and Grandmother Singer?

Sara: Yes, I have. I've written to both grandmothers.

Mrs. Taylor: \_\_\_\_\_?

Sara: Yes, I've picked up my clothes at the cleaner's.

Mrs. Taylor: \_\_\_\_\_?

Sara: Yes, I've put my traveller's checks in my bag.

Mrs. Taylor: \_\_\_\_\_?

Sara: Yes, I've written down the addresses of all my friends in Fairbanks.

Mrs. Taylor: \_\_\_\_\_?

Sara: Yes, I've said good-bye to all the neighbors.

Mrs. Taylor: \_\_\_\_\_?

Sara: Yes, I've sent a letter to Roberta and his family.

Mrs. Taylor: \_\_\_\_\_?

Sara: Yes, I've bought them a present.

Mrs. Taylor: \_\_\_\_\_?

Sara: Yes, I've put my tickets in my bag.

Mrs. Taylor: \_\_\_\_\_?

Sara: No, I haven't. I haven't called the airline to confirm my flight reservation.

Mrs. Taylor: Don't worry. I'll do that for you right now. Then you won't have any trouble at the airport.

### IV. **Controlled Composition** Dicto-comp

Your teacher will read the letter on the next page three times. Listen carefully, but do not take notes. After the third reading, write the letter as well as you can from memory. Check the spelling of participles and contractions.

May 20, 1983

Dear Sara,

I've received your letter, and I'm looking forward to your visit. We'll be happy to meet you. My mother has cleaned the extra bedroom. We've made everything ready for you. We've called your uncle already. He's very nice. We've asked you both to come for dinner. We hope you'll stay for a long visit.

Yours,  
Roberto

V. **Grammar** Indefinite pronouns: some, any and one

The words some, any, and one can be used as pronouns to stand for nouns that have already been mentioned. The noun that is mentioned first is called the antecedent; the pronoun refers back to its antecedent.

We use one for singular count nouns. Some and any are pronouns for plural or noncount nouns. Finish the sentences below, using some, any, or one. Follow the examples.

1. Sara doesn't have a dog, but she wants one.
2. Sara doesn't have new clothes, but she wants some.
3. Sara hasn't had any trouble, and she doesn't want any.
4. Sara doesn't have a big house,
5. Sara doesn't have a sister,
6. Sara doesn't have any money,
7. Sara doesn't have any new shoes,
8. Sara doesn't have any problems,
9. Sara doesn't have any new records,
10. Sara doesn't have Venezuelan music,
11. Sara doesn't have a job,
12. Sara doesn't have a boyfriend,

VI. **Grammar** Sentence combining practice

Use conjunctions or conjunctive adverbs to combine the pairs of sentences below. Remember that the punctuation rules are different for conjunctions and adverbs.

1. Many young people want to travel to other countries.  
They don't have enough money. (but)

2. Air travel and hotels are very expensive.  
There are other ways to see foreign countries, (however)
3. Educational exchanges are cheaper than vacations.  
They involve valuable learning experience, (in addition)
4. Most young Americans have part-time jobs.  
They can save some money for travel, (as a result)
5. Sara goes to school and helps her mother.  
She finds time to work at a grocery store, too. (even though)
6. She has \$1000 of her own money.  
She is planning to visit her uncle in Venezuela, (so)
7. Sara works hard.  
She has very little free time. (so...that)
8. Sara often works.  
Her friends are having fun. (while)
9. She likes to have fun with her friends.  
She has exciting travel plans, (on the other hand)
10. She can't go to Venezuela.  
She pays for part of the airplane ticket, (unless)
11. Sara has an uncle in Caracas.  
She doesn't need to pay for a hotel, (therefore)
12. Sara will be very happy.  
She sees her uncle and her friends in Venezuela, (when)

## VII. **Sentence Construction** Writing complete sentences

There is a great difference between spoken English and written English. In speech, people use more contractions and more incomplete sentences than they do in writing. It is common to use a subordinate clause alone in speaking. However, in writing English, a subordinate clause must always be combined with a main clause.

The short conversations below are acceptable in spoken English. However, the answer in each conversation is an incomplete sentence. Rewrite each incomplete sentence with a main clause. Follow the example.

1. "When will we eat the cake?"  
"When the guests arrive."  
We will eat the cake when the guests arrive.
2. "How long must we wait?"  
"Until they come."

3. "Can I eat two pieces?"  
"If there's enough cake."
4. "When can I have my second piece?"  
"After the guests have eaten."
5. "When will we have the coffee?"  
"While we're eating the cake."
6. "When will the guests be here?"  
"Before 7:00."
7. "Are they coming soon?"  
"Unless they've forgotten."
8. "Why do I have to wait?"  
"Because you are the host and they are the guests."

### VIII. Vocabulary and Spelling    Past participles as adjectives

Past participles are often used as adjectives, even though they look like verbs. They may come before the noun or after the verb to be, just like other adjectives:

He is a tired man.  
The dog was lost.

Read each definition below; and write each participle as an adjective before a noun. Each singular count noun needs an article, a or an. Follow the examples.

1. a dessert that has been frozen    a frozen dessert
2. bread that has been buttered    buttered bread
3. a banana that has been peeled
4. sauce that has been heated
5. cream that has been whipped
6. nuts that have been chopped
7. chicken that has been fried
8. vegetables that have been canned
9. fruit that has been dried
10. apples that have been baked
11. a child who has been frightened
12. a man who has grown
13. a record that has been broken

14. a woman who has married
15. a traveller who has worried
16. a man who has been educated
17. a student who has been bored
18. air that has been polluted
19. space that has been limited
20. a child who has been lost

# PHOBIAS

Phobias are very strong fears which may start in childhood. Usually there has been an early experience which started the fear. A person may forget the experience which started the fear, but the fear remains. For example, a person who is afraid of closed rooms has claustrophobia. Perhaps that person had parents who once locked him in a closet as a child. As an adult, he has forgotten the experience in the closet, but he fears locked rooms.



Claustrophobia



A person who is afraid of insects has a kind of zoophobia. People who are afraid of snakes, spiders, and mice have zoophobia, too. People who are afraid of germs have microphobia. They wash their hands many times a day, and they refuse to be near people who are sick. Now that we understand disease better, many people are microphobic—afraid of germs.

Zoophobia

## I. **Mechanics** Non restrictive relative clauses

One method of combining sentences is to use a non restrictive relative clause. In this clause, you give extra information about a person or a thing that you already know. Non restrictive relative clauses are separated from the rest of the sentence with commas.

The following sentences all contain nonrestrictive clauses. Copy the sentences and make all the corrections that are necessary. Set off the nonrestrictive clauses with commas. Follow the example.

1. my uncle louis who runs a grocery store is afraid of germs  
My uncle Louis, who runs a grocery store, is afraid of germs.
2. his store which is in the middle of the city is always very clean
3. he never sells milk which can become sour
4. he never sells meat which can turn bad
5. he never sells vegetables which can carry germs
6. he sells only canned food which doesn t go bad
7. uncle louis who has microphobia is hard to live with
8. aunt selma who is my mother s sister can t go near him
9. the children whose names are don and candy never touch him
10. this problem which started after his sickness last year is more serious than the sickness was

## II. **Grammar** Restrictive relative clauses

Restrictive relative clauses restrict, or limit, the meaning of the noun they follow. They make a noun less general and more specific, and so they help to identify the noun. For example, this sentence is so general that it is not true:

A man is hard to live with. However, a restrictive relative clause will make the statement true:

A man who has microphobia is hard to live with.

Notice that restrictive clauses are not separated from the rest of the sentence by commas.

Combine the sentence pairs below into one longer sentence. Substitute the relative pronoun who for the underlined words.

1. A person...has pathophobia. He is afraid of disease.  
A person who is afraid of disease has pathophobia.



2. A person...has claustrophobia. He is afraid of closed places.
3. A person...has zoophobia. He is afraid of snakes.
4. A person...has zoophobia. He is afraid of mice.
5. A person...has xenophobia. He is afraid of strange people.

Substitute the pronoun whose for the underlined word and combine the two sentences.

6. Aunt Selma is the woman. Her husband has microphobia.  
Aunt Selma is the woman whose husband has microphobia.
7. Louis is the man. His grocery store is so clean.
8. He is the man. His phobia is hard to live with.
9. He is the man. His hands are always clean.
10. Don and Candy are the children. Their father is so sick.

Substitute the pronoun which for the underlined words.

11. Phobias are strong fears. They may start in childhood.
12. Uncle Louis has a phobia. It began with his sickness last year.
13. It must be his sickness. It started the phobia.
14. Usually there has been an early experience. It started the fear.
15. A doctor may ask questions. They will help him remember.

Substitute the pronoun which for the underlined words and move the pronoun to a position between the two sentences.

16. A person may do things. He doesn't understand them.  
A person may do things which he doesn't understand.
17. A person may have experiences. He doesn't remember them.
18. A person may have fears. He cannot live with them.
19. A person may have feelings. He cannot talk about them.

### III. Grammar Subject-verb agreement

The verb in the relative clause must agree with the antecedent in the main clause. If the antecedent is plural, the verb is plural. If the antecedent is singular, the verb is singular. Study the examples below:

I know a person who is afraid of the dark.  
(singular) (singular)

I know many people who are afraid of the dark.  
(plural) (plural)

Find the antecedent for each relative clause below. Copy the paragraph, and write in the correct form of the verb in each blank.

There are many phobias which actually \_\_\_\_\_ (protect, protects) people. There are many people who \_\_\_\_\_ (is, are) afraid of heights. Acrophobia, which \_\_\_\_\_ (is, are) the fear of high places, helps people to be careful. A person who \_\_\_\_\_ (is, are) careless in a high place may fall and hurt himself. Another phobia which \_\_\_\_\_ (is, are) actually helpful is pyrophobia. People who \_\_\_\_\_ (has, have) pyrophobia are afraid of fire. Fire is one thing which \_\_\_\_\_ (is, are) really dangerous.

#### IV. **Controlled Composition** Dicto-comp

Your teacher will read the paragraph above three times. Listen carefully, but do not take notes. After the third reading, write the paragraph as well as you can from memory. Try to use relative clauses, and check your subject-verb agreement.

#### V. **Sentence Construction** Writing definitions

Write a one-sentence definition for each word below. Use a main clause and a restrictive relative clause to limit it.

Example: a truck driver A truck driver is a person who drives a truck.  
a clothes drier A clothes drier is a machine which dries clothes.

1. a bus driver
2. a cat lover
3. a short story writer
4. a dishwasher
5. a money earner
6. a vegetable farmer
7. a space heater
8. a city planner

#### VI. **Grammar** Substituting that for which or who

In informal writing and in spoken English, the word that is often used instead of which or who. All of the sentences below can take that as the

relative pronoun. Rewrite the paragraph and substitute that for which or who.

What is the worst thing which ever happened to you? The worst thing which ever happened to me was this. When I was a little girl, we had an old icebox which we kept in back of the house. It belonged to the people who had lived there before us. It was small, and it had a door which closed tight. There was a shelf which had held large pieces of ice. The shelf was always empty, for nobody used the icebox any more. The shelf made a little seat which was very comfortable. I liked to sit there. It was a habit which almost cost me my life. One day I was sitting in the icebox, and my brother closed the door. There was nobody who could let me out. Soon the air which was in the icebox was almost gone. I screamed and made noise until my mother opened the door. It was an experience which I will never forget. Now I have a great fear of closed places, and I always will.

## VII. **Controlled Composition** Organizing ideas

The sentences below can be arranged into two paragraphs describing how people can lose their phobias. However, the sentences are out of order now, and they are not in proper paragraph form. Arrange the sentences into a clear order and copy the paragraphs.

### “Losing a Phobia”

#### Paragraph 1

The fear started when she was four years old.  
My sister has ochlophobia, which is the fear of crowds.  
She was very upset.  
We were in a crowd of people at a fair, and she got lost.  
She was lost for four hours before we found her.

#### Paragraph 2

Every day he goes with her to a crowded place.  
Now she is 18 years old.  
The first day they didn't go very far into the crowd.  
She is seeing a doctor to help her lose her fear.  
She is becoming less afraid every day.  
The second day they went a little farther.  
The third day they went even farther.  
Soon she will be able to live a normal life.

### VIII. **Vocabulary and Spelling** Present participles as adjectives

Present participles are -ing verb forms. They can be used like adjectives, before a noun.

That is a tiring trip. That is exciting news.

Read each definition below, and write each -ing form as an adjective, with a noun. Singular count nouns need articles. Follow the examples.

1. a dog that is sleeping     a sleeping dog
2. information that excites you     exciting information
3. a dog that is barking
4. weather that freezes you
5. a dish for baking
6. a story that frightens you
7. a boy who is growing
8. a team that is losing
9. a mother who is working
10. a machine for washing
11. water that is running
12. a team that is winning

## CHAPTER TWENTY

# A DAY AT THE BEACH



Sara: What a beautiful beach! Just look at the water. I can hardly wait to go in.

Sara's Uncle: It is very popular. At least, it's certainly crowded.

Roberto: We'll see many people that we know. Hey! There's my cousin Luis!

Sara: Really? Which one?

Roberto: The one in the green swimming suit.

Sara: I see two guys in green. Is he the tall one or the short one?

Roberto: The tall one with black hair.

Mrs. Perez: And there's Maria, too.  
She's Luis' sister.

Sara: Which girl is she?

Roberto: The short one in the red suit, with sunglasses.

Sara: We'll meet your whole family here today.



## I. **Mechanics** Quotations and paragraphs

The conversation above is in dialog form like a play. Conversation can also be written in paragraph form, and each new speaker has a new paragraph. Copy the sentences below in paragraph form. Use quotation marks for the exact words of each speaker. Remember to indent each new paragraph. Make all other corrections that are necessary.

what a beautiful beach said sara just look at the water i can hardly wait to go in it is very popular her uncle answered at least it s certainly crowded we ll see many people that we know roberto told them hey there s my cousin luis really asked sara which one the one in the green swimming suit replied roberto is he the tall one or the short one asked sara the tall one with the black hair said roberto

## II. **Grammar** Final review of articles

<u>General meaning</u>	<u>Singular</u> <u>Count</u>	<u>Plural</u> <u>Count</u>	<u>Noncount</u> <u>Noun</u>
(first mention, or the identity of the noun is not known.)	<u>a</u> friend <u>an</u> idea (You must use an article.)	<u>X</u> books (No article means all books in general.) OR <u>some</u> books ("Some" gives the idea of an indefinite, limited number	<u>X</u> food (No article means all food in general.) OR <u>some</u> food ("Some" gives the idea of an indefinite, limited quantity.)
<u>Specific meaning</u> (second mention, or any other time when the identity of the noun is known.)	the friend the idea	the books	the food

The chart above is a summary of the rules for articles in this book. Use

the chart to fill in the blanks in the paragraph below.

A. When \_\_\_\_ person takes \_\_\_\_ trip to \_\_\_\_ beach, he should bring \_\_\_\_ things to make \_\_\_\_ trip more pleasant. He will need \_\_\_\_ towel, \_\_\_\_ frisbee, \_\_\_\_ books, \_\_\_\_ food, \_\_\_\_ suntan oil, \_\_\_\_ sunglasses, \_\_\_\_ money, and \_\_\_\_ radio. I always bring \_\_\_\_ friend along, too. We sit on \_\_\_\_ towel, read \_\_\_\_ books, eat \_\_\_\_ food, and listen to \_\_\_\_ radio. Then we play with \_\_\_\_ frisbee. Of course, we spend \_\_\_\_ money, too.

The definite article the can be used the first time we mention a noun if the noun is unique, or the only one of its kind. This means that the identity is already known. Some examples of unique nouns are: the sun, the moon, the ceiling, the floor. If you are in a room with only one door, you can say the door. If you are at a beach and everyone is swimming in the same water, you can say the water.

Copy the paragraph below and choose articles to fill in the blanks.

B. When you go to \_\_\_\_ beach at Miami, be careful of \_\_\_\_ sun. \_\_\_\_ sun is strong and hot. Stay in \_\_\_\_ water as much as you can. If \_\_\_\_ sky is clear, \_\_\_\_ danger of sunburn is great. If \_\_\_\_ sky is cloudy, you can stay out longer. Always check \_\_\_\_ weather before you go to \_\_\_\_ beach.

### III. **Controlled Composition** Dicto-comp

Your teacher will read the paragraph above (either IIA or IIB) three times. Listen carefully, but do not take notes. After the third reading, write the paragraph as well as you can from memory. Check your use of articles.

### IV. **Grammar** Reduced relative clauses

Relative clauses can be made shorter sometimes by taking out the subject and the auxiliary verb, and leaving a phrase. The phrase that remains can be a prepositional phrase or a participial phrase. It acts like an adjective to describe the noun it follows. Study the examples below:

The boy who is in the green swimming suit is my cousin.

The boy in the green swimming suit is my cousin.

The girl who is wearing a red suit is his sister.

The girl wearing a red suit is his sister.

The fruit that is grown in Venezuela is delicious.

The fruit grown in Venezuela is delicious.

The girl who has the dark sunglasses is Maria.

The girl with the dark sunglasses is Maria.

(Notice that the verb to have can be changed to the preposition with. They both show possession, with no change of meaning.)

Rewrite the sentences below. Change the relative clauses to prepositional or participial phrases.

1. The tall one who has black hair is Luis.
2. The short one who is in the red suit is Maria.
3. The one who has sunglasses is his sister.
4. The woman who is wearing a beach coat is my mother.
5. The girl who has the bad sunburn is my sister.
6. The food that is sold on the beach always tastes good.
7. Chocolate that is left in the sun will melt.
8. The man who is swimming after those children is the lifeguard.
9. The man who is eating vanilla ice cream is my father.
10. The girl who is from Alaska is Sara Taylor.
11. The children who are playing in the water are my cousins.
12. The tall one who is in the deep water is a good swimmer.
13. The fat one who is on the pink towel is too lazy to swim.
14. All the people who are on the beach are having fun.
15. Many people who are from the city come here every weekend.

#### V. **Sentence Construction** Indefinite pronouns: one, ones, and kind

The word one is a pronoun for any single count noun. Answer each question using the pronoun one and adjectives to define it. Follow the example.

Do you know any of the girls here? (tall, in the blue suit)

Yes, I know the tall one in the blue suit.

1. Do you have a beach towel here? (red, with the picture of Mickey Mouse)
2. Do you like any of the books here? (new, about jazz music)
3. Do you know any of those children? (little, with the red hair)



4. Does one of these swimming suits belong to you?  
(brown, with yellow flowers)
5. Do you know any of the men here? (tall, in the yellow coat)
6. Do you know any of the girls here? (thin, from Fairbanks)

Ones is a pronoun for plural nouns. Answer each question using the pronoun ones and an adjective phrase to define it. Follow the example below.

Do you like folk songs? (sad, about love)

Yes, I like sad ones about love.

7. Do you like folk songs? (funny, about people)
8. Do you like sports cars? (foreign, with fast engines)
9. Do you like desserts? (sweet, with lots of whipped cream)
10. Do you like folk dances? (Latin, with colorful costumes)
11. Do you like radio shows? (popular, with modern music)

The kind is like a pronoun for noncount nouns. Answer each question using the words the...kind and adjectives to define it. Follow the example below.

Do you like Mexican food? (hot, with lots of peppers)

Yes, I like the hot kind with lots of peppers.

12. Do you like pizza? (thick, with lots of cheese)
13. Do you like music? (classical, with a full orchestra)
14. Do you like this weather? (hot, with lots of sun)
15. Do you like candy? (sweet, with chocolate and nuts)

## VI. Grammar Choosing prepositions

Copy the paragraph below, choosing a preposition to fill each blank.

There are many people \_\_\_\_\_ the beach today. Many are lying \_\_\_\_\_ towels, and many are \_\_\_\_\_ the water. Most people are \_\_\_\_\_ swimming suits, but some women are \_\_\_\_\_ dresses. The tall man \_\_\_\_\_ the dark hair is \_\_\_\_\_ Alaska. The short woman \_\_\_\_\_ the red swimming suit is watching her children \_\_\_\_\_ the water. They can't stay \_\_\_\_\_ the sun too long, or they will burn. People \_\_\_\_\_ light skin have to be very careful. People \_\_\_\_\_ the city don't spend much time \_\_\_\_\_ the sun.

## VII. **Controlled Composition** Variety in sentence types

Good writers use some short, simple sentences and some longer sentences. Rewrite the story below and vary the length of the sentences. Combine some sentences by using relative clauses or reduced relative clauses.

Sara Taylor arrived in Caracas on June 14. Her uncle met her at the airport. They were walking to the luggage counter. They saw a young boy. He was wearing a blue shirt. He was wearing dark pants. He was with an older woman. She was in a white dress. He was with an older man. The older man was dressed in a business suit. The boy was carrying a large present. The present had a ribbon on it. The boy looked at Sara and her uncle carefully. They were the only Americans. They were speaking English. They were in the airport. The young boy came up to Sara and her uncle. The young boy was in the blue shirt and the dark pants.

“Excuse me,” he said. “Are you Sara Taylor? I am Roberto Perez. Welcome to Caracas!”

The woman was Roberta’s mother. She was in the white dress. The man was Roberto’s father. He was in the business suit. They gave the present to Sara. They welcomed her to Venezuela.

## VIII. **Vocabulary and Spelling** Irregular verbs

Find the past tense or participle form for the irregular verbs on page 134. Use these words to fill in the crossword puzzle. You may look at the list of irregular verbs in the appendix at the back of the book.

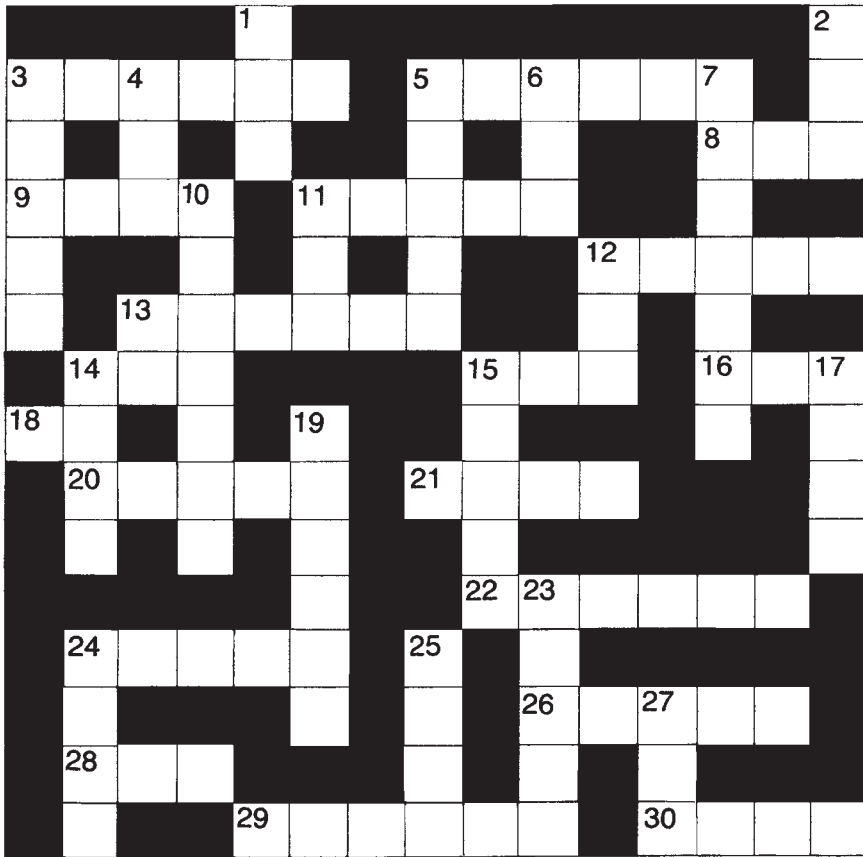

**DOWN**

- 1. past of feed
- 2. past of hide
- 3. past of begin
- 4. past of eat
- 5. participle for fly
- 6. participle for run

- 7. participle for think
- 10. participle for write
- 11. past of get
- 12. past of do
- 13. simple form of is
- 14. past of lose
- 15. past of hear

- 17. past of tell
- 19. participle for steal
- 23. participle for rise
- 24. past of come
- 25. past of sink
- 27. past of lead

**ACROSS**

- 3. participle for beat
- 5. past of forget
- 8. past of hide
- 9. past of grow
- 11. participle for grow
- 12. participle for drink

- 13. participle for bite
- 14. past of let
- 15. past of have
- 16. past of hit
- 18. simple form of does
- 20. past of spend
- 21. past of sing

- 22. participle for drive
- 24. past of choose
- 26. past of split
- 28. past of meet
- 29. participle for speak
- 30. participle for do

# APPENDIX A

## COMMON IRREGULAR VERBS

The verbs below are the ones most commonly used in English. Most are found in the texts and exercises in this book.

<u>Simple Form</u>	<u>Past Tense</u>	<u>Participle</u>
be	was, were	been
beat	beat	beaten
become	became	become
begin	began	begun
bend	bent	bent
bet	bet	bet
bite	bit	bitten
blow	blew	blown
break	broke	broken
bring	brought	brought
build	built	built
buy	bought	bought
catch	caught	caught
choose	chose	chosen
come	came	come
cost	cost	cost
cut	cut	cut
dig	dug	dug
do	did	done
drink	drank	drunk
drive	drove	driven
eat	ate	eaten
fall	fell	fallen
feed	fed	fed
feel	felt	felt
fight	fought	fought
find	found	found
fly	flew	flown
forget	forgot	forgotten
forgive	forgave	forgiven
freeze	froze	frozen

Simple FormPast TenseParticiple

get

got

gotten

give

gave

given

go

went

gone

grow

grew

grown

have

had

had

hear

heard

heard

hide

hid

hidden

hit

hit

hit

hold

held

held

hurt

hurt

hurt

keep

kept

kept

know

knew

known

lay

laid

laid

lead

led

led

leave

left

left

lend

lent

lent

let

let

let

lie

lay

lain

light

lit

lit

lose

lost

lost

make

made

made

mean

meant

meant

meet

met

met

pay

paid

paid

put

put

put

quit

quit

quit

read

read

read

ride

rode

ridden

ring

rang

rung

rise

rose

risen

run

ran

run

say

said

said

see

saw

seen

sell

sold

sold

send

sent

sent

set

set

set

shake

shook

shaken

Simple Form

show  
sing  
sink  
sit  
sleep  
speak  
spend  
split  
spread  
stand  
steal  
swim  
take  
teach  
tear  
tell  
think  
throw  
understand  
wear  
win  
write

Past Tense

showed  
sang  
sank  
sat  
slept  
spoke  
spent  
split  
spread  
stood  
stole  
swam  
took  
taught  
tore  
told  
thought  
threw  
understood  
wore  
won  
wrote

Participle

shown  
sung  
sunk  
sat  
slept  
spoken  
spent  
split  
spread  
stood  
stolen  
swum  
taken  
taught  
torn  
told  
thought  
thrown  
understood  
worn  
won  
written

# APPENDIX B—REVIEW OF GRAMMAR

## ARTICLES

Rules for the use of articles are listed below, in the order they appear in the book. To review the rules and to practice using articles, see the chapter and exercise that is given.

- Choosing a or an for single count nouns 3.V
- A or an with single count nouns 6.VII
- No articles before a person's name 6.VII
- No article with plural nouns, in general 6.VII
- Definite article the before some place names 7.II
- No article with noncount nouns, in general 8.IV, 8.V
- Initial review of rules for articles with common nouns 9.II
- Definite article the for second mention of nouns 9.III
- Definite article the with defining phrases 12.V, 13. VI
- Some as a quantifier with plural and noncount nouns 16.V
- Indefinite pronouns: some, any, and one 18.V
- Final review of rules for articles with common nouns 20.II
- Definite article the with unique nouns 20.II
- Indefinite pronouns: one, ones, and kind 20.V

## PUNCTUATION

Punctuation rules are listed below, in the order they appear in the book. To review the rules and to practice using punctuation, see the chapter and exercise that is given.

- Periods at the end of sentences 1.I
- Apostrophe for contractions with be 3.I
- Apostrophe for possessive's 3.III
- Question mark at the end of questions 5.I
- Exclamation point showing strong emotion 6.I
- Comma between coordinate clauses 7.III
- Commas between items in a series 12.I
- Colon before a list of examples 14.I
- Quotation marks 15.I
- Comma after a subordinate clause 16.I
- Semi-colon in sentence combining 17.I

Apostrophe for contractions with have and will 18.I  
Commas in nonrestrictive relative clauses 19.I  
Quotations and paragraph form 20.1

## CAPITALIZATION

Capitalization rules are listed below, in the order they appear in the book. To review the rules and to practice using capital letters, see the chapter and the exercise that is given.

Names of people 1.I  
Beginning of a sentence 1.I  
Nationalities 2.I  
Days of the week 2.I  
Names of streets, cities, states, and countries 5.I  
Names of continents, oceans, rivers, mountains,  
and valleys 7.I  
Months of the year 7.I  
Names of companies and stores 13.I

## SPELLING RULES FOR INFLECTIONAL ENDINGS

Spellings rules for inflectional endings are listed below, in the order they appear in the book. To review the rules and to practice applying them, see the chapter and the exercise that is given.

Third person -s forms, present tense 2.II  
Noun plurals 3.II  
Possessive's 3.III  
Present progressive -ing forms 12.II  
Adjective comparison, -er, -est forms 13.II  
“Agent” suffix -er 13.VIII  
Past tense -ed forms 14.III

## WORD ORDER

Rules for various kinds of word order are listed below, in the order they appear in the book. To review the rules and to practice applying them, see the chapter and the exercise that is given.



Sentence patterns with be 1.V  
Sentence patterns with present tense verbs 2.V  
Adverbs of frequency with be and other main verbs 2.VI  
Adverbs of time at the beginning of the sentence 2.VII  
Questions with be 5.V  
Questions with other main verbs (do) 5.VI  
Negative statements with don't and doesn't 6.II  
Sentence combining with coordinate conjunctions 7.III  
Adjectives before nouns 7.V  
Sentence combining with the main verb deleted 8.II  
Single-word compound nouns 9.VIII  
Statements with There is and There are 10.III  
Questions with Is there and Are there 10.IV  
Prepositional phrases at the beginning of the sentence 10.V  
Two-word compound nouns 10. VIII  
Information questions (wh- words) 11.II  
Sentence patterns with the present progressive 12.III, 12.VI  
Sentence combining with compound sentence parts 14.VI  
Questions and negatives in the past 15.IV  
Sentence patterns with the past progressive 16.II  
Sentence combining with subordinate conjunctions 16.IV  
Sentence combining with conjunctive adverbs 17.II  
Sentence patterns with the present perfect 18.II  
Questions with the present perfect 18.III  
Complete sentences vs. fragments 18. VII  
Past participles as adjectives before nouns 18. VIII  
Sentence combining with restrictive relative clauses 19.II  
Present participles as adjectives before nouns 19.VIII  
Reduced relative clauses 20.IV

# APPENDIX C

## ANSWERS TO PUZZLES

Page 7

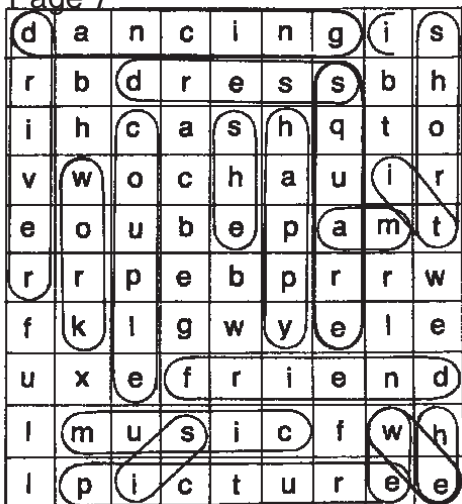

Page 24

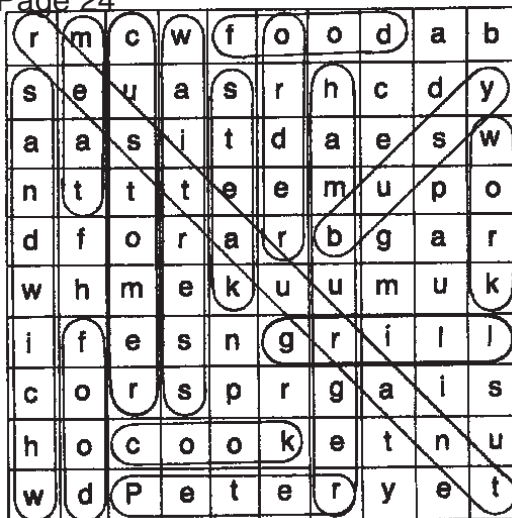

Page 43

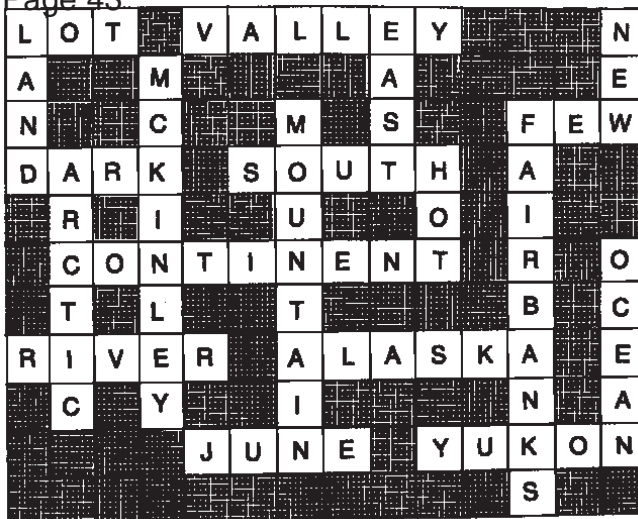

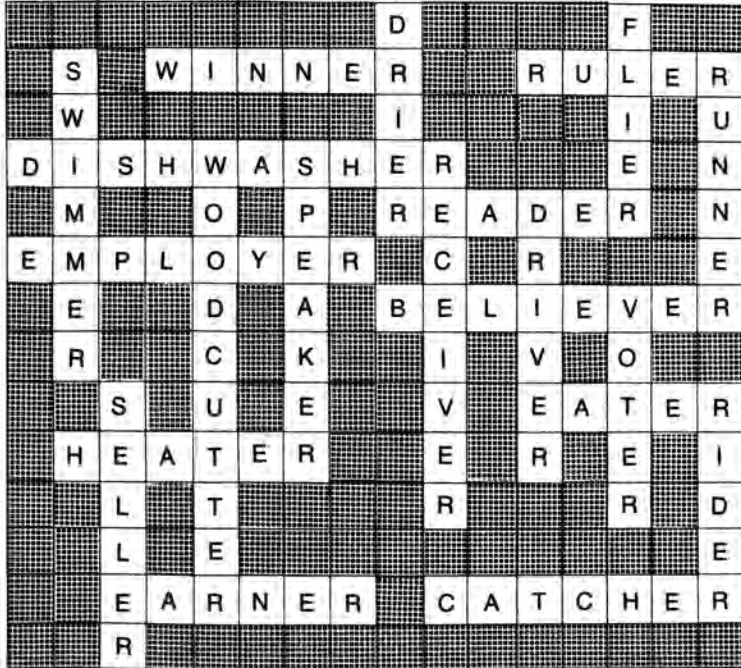



# *Developing Writing* Writing Skills Practice Book for EFL

PATRICIA WILCOX PETERSON

Each of the twenty chapters in *Developing Writing* is introduced by a topical reading selection incorporating the lesson's model structures, mechanics, and grammar points. Following each reading are activities designed for students to study composition, vocabulary, and spelling. The goal of this book is to take the student from the mechanics of basic sentence writing to the ability to construct a simple paragraph. Appendices include an irregular verb list, grammar rule index, and answer keys.



UNITED STATES DEPARTMENT OF STATE  
Office of English Language Programs